

PJT Open Frame Power Supply

PJT-65W Series / PJT-□□V65WBAA

PJT

Highlights & Features

- Universal AC input voltage
- Standard industrial foot print of 2" x 4"
- Low leakage current < 0.1 mA
- Convection cooled operating temperature range from -10°C to +70°C
- High MTBF > 700,000 hrs as per Telcordia SR-332
- Multiple connector source options

Safety Standards



CB Certified for worldwide use



Model Number: PJT-□□V65WBAA
Unit Weight: 0.13 kg (0.29 lb)
Dimensions (L x W x H): 101.6 x 50.8 x 30 mm [2" x 4"]

General Description

The PJT open frame power supply series offers choices of 12 V, 15 V, 18 V and 24 V nominal output voltages. The single output products are designed with small standard industrial footprints at 2" x 4". The highly efficient convection cooling designs enable optimum thermal management for high power efficiency. The PJT series of products can operate from -10°C to +70°C across the entire input voltage range of 90 to 264 Vac and are certified for safety standard according to IEC/EN/UL 62368-1 and for EMI standard according to EN/BS EN 55032, Class B.

Model Information

PJT Open Frame Power Supply

Model Number	Input Voltage Range	Rated Output Voltage	Rated Output Current
PJT-12V65WBAA	90-264 Vac	12 Vdc	5.00 A
PJT-15V65WBAA		15 Vdc	4.20 A
PJT-18V65WBAA		18 Vdc	3.61 A
PJT-24V65WBAA		24 Vdc	2.71 A

Model Numbering

PJ	T –	XXV	65W	B	A	A
Open Frame	Product Type T – ITE Application Series	Output Voltage 12 V 15 V 18 V 24 V	Output Power (65W series model)	Package Type B – Open Frame	Family Code A	Harness Connector A – JST connector

*Options

PJT Open Frame Power Supply

PJT-65W Series / PJT-□□V65WBAA

Specifications

	Model Number	PJT-12V65WBAA	PJT-15V65WBAA	PJT-18V65WBAA	PJT-24V65WBAA
--	--------------	---------------	---------------	---------------	---------------

Input Ratings / Characteristics

Nominal Input Voltage	100-240 Vac				
Input Voltage Range	90-264 Vac				
Nominal Input Frequency	50-60 Hz				
Input Frequency Range	47-63 Hz				
Input Current	< 1.50 A typ. @ 115 Vac				
Efficiency at 100% Load	115 Vac	86.0% typ.	87.0% typ.	87.0% typ.	87.0% typ.
	230 Vac	86.5% typ.	88.5% typ.	88.0% typ.	
Max Power Dissipation	0.3 W (0% load)				
Max Inrush Current (Cold Start)	30 A typ. @ 115 Vac, 60A typ. @ 230 Vac				
Leakage Current	0.1 mA @ 240 Vac				

Output Ratings / Characteristics

Nominal Output Voltage	12 Vdc	15 Vdc	18 Vdc	24 Vdc
Factory Set Point Tolerance	No potentiometer (± 5%)			
Output Current	5.00 A	4.20 A	3.61 A	2.71 A
Output Power	60 W	63 W	65 W	65 W
Line Regulation	± 0.5% @ 115 Vac & 230 Vac			
Load Regulation	± 1.0% @ 115 Vac & 230 Vac			
PARD* (20MHz)	< 120 mVpp	< 150 mVpp	< 180 mVpp	< 240 mVpp
Start-up Time	115 Vac	3000 ms typ. (100% load)		
	230 Vac	1500 ms typ. (100% load)		
Hold-up Time	115 Vac	16 ms typ. (100% load)		
	230 Vac	80 ms typ. (100% load)		
Dynamic Response (Overshoot & Undershoot O/P Voltage)	± 5% @ 50-100% load (Slew Rate: 0.1 A/μS)			
Start-up with Capacitive Loads	4,000 uF Max	3,500 uF Max	3,000 uF Max	2,000 uF Max

*PARD is measured with an AC coupling mode, 5cm wires, and in parallel with 0.1 μF ceramic capacitor & 47 μF electrolytic capacitor.

Mechanical

Dimensions	101.6 x 50.8 x 30 mm [2" x 4"]	
Unit Weight	0.13 kg (0.29 lb)	
Cooling System	Convection	
Terminal	PJT-□□V65WBAA	Input: JST B2P3-VH (LF)(SN) Output: JST B4P-VH (LF)(SN)
Wire	AWG 22-18	

PJT Open Frame Power Supply

PJT-65W Series / PJT-□□V65WBAA

Environment

Surrounding Air Temperature	Operating	-10°C to +70°C
	Storage	-40°C to +85°C
Power De-rating	> 50°C de-rate power by 2.5% / °C	
Operating Humidity	10 to 95% RH (Non-Condensing)	
Operating Altitude	0 to 5,000 Meters (16,400 ft.)	
Shock Test (Non-Operating)	IEC 60068-2-27, Half Sine Wave: 50 G for a duration of 11 ms, 3 shocks for each 3 directions	
Vibration (Operating)	IEC 60068-2-6, Sine Wave: 10 Hz to 150 Hz @ 25 m/S ² (2.5 G); 10 min per cycle, 90 min per axis for all X, Y, Z direction	

Protections

Overvoltage	13.2-18.0 V, Latch Mode	16.5-22.5 V, Latch Mode	19.8-27.0 V, Latch Mode	26.4-36.0 V, Latch Mode
Overload / Overcurrent	> 125% of rated load current, Hiccup Mode, Non-Latching (Auto-Recovery)			
Over Temperature	Non-Latching (Auto-Recovery)			
Short Circuit	Hiccup Mode, Non-Latching (Auto-Recovery when the fault is removed)			
Protection Against Shock	Class I with PE* connection			

*PE: Primary Earth

Reliability Data

MTBF	> 700,000 hrs. as per Telcordia SR-332
------	--

Safety Standards / Directives

Electrical Safety	TUV Bauart UL/cUL recognized	EN 60950-1, EN 62368-1 UL 60950-1 and CSA C22.2 No. 60950-1 (File No. E131881), UL 62368-1 and CSA C22.2 No. 62368-1 (File No. E131881) CCC, BSMI
	CB scheme	IEC 60950-1, IEC 62368-1
CE	In conformance with EMC Directive 2014/30/EU and Low Voltage Directive 2014/35/EU	
UKCA	In conformance with Electromagnetic Compatibility Regulations 2016 and Electrical Equipment (Safety) Regulations 2016	
Galvanic Isolation	Input to Output	3.0 KVac
	Input to Ground	2.0 KVac
	Output to Ground	0.5 KVac

PJT Open Frame Power Supply

PJT-65W Series / PJT-□□V65WBAA

EMC

Emissions (CE&RE)		CISPR 32, EN/BS EN 55032, FCC Title 47: Class B
Immunity to		EN/BS EN 55024
Electrostatic Discharge	IEC 61000-4-2	Criteria A ¹⁾ Level 3 Air Discharge: 8 kV Level 3 Contact Discharge: 6 kV
Radiated Field	IEC 61000-4-3	Level 2 Criteria A ¹⁾ 80 MHz-1 GHz, 3 V/M with 1 kHz tone / 80% modulation
Electrical Fast Transient / Burst	IEC 61000-4-4	Level 3 Criteria A ¹⁾ 2 kV
Surge	IEC 61000-4-5	Level 3 Criteria A ¹⁾ Common Mode ²⁾ : 2 kV Differential Mode ³⁾ : 1 kV
Conducted	IEC 61000-4-6	Level 2 Criteria A ¹⁾ 3 V with 80% AM
Power Frequency Magnetic Fields	IEC 61000-4-8	Criteria A ¹⁾ Magnetic field strength 3A/Meter
Voltage Dips	IEC 61000-4-11	30% dip; 10 ms Criterion A 60% dip; 100 ms Criterion B 95% dip; 5000 ms Criterion B
Voltage Fluctuation and Flicker		IEC/EN/BS EN 61000-3-3

- 1) Criteria A: Normal performance within the specification limits
- 2) Asymmetrical: Common mode (Line to earth)
- 3) Symmetrical: Differential mode (Line to line)

Block Diagram

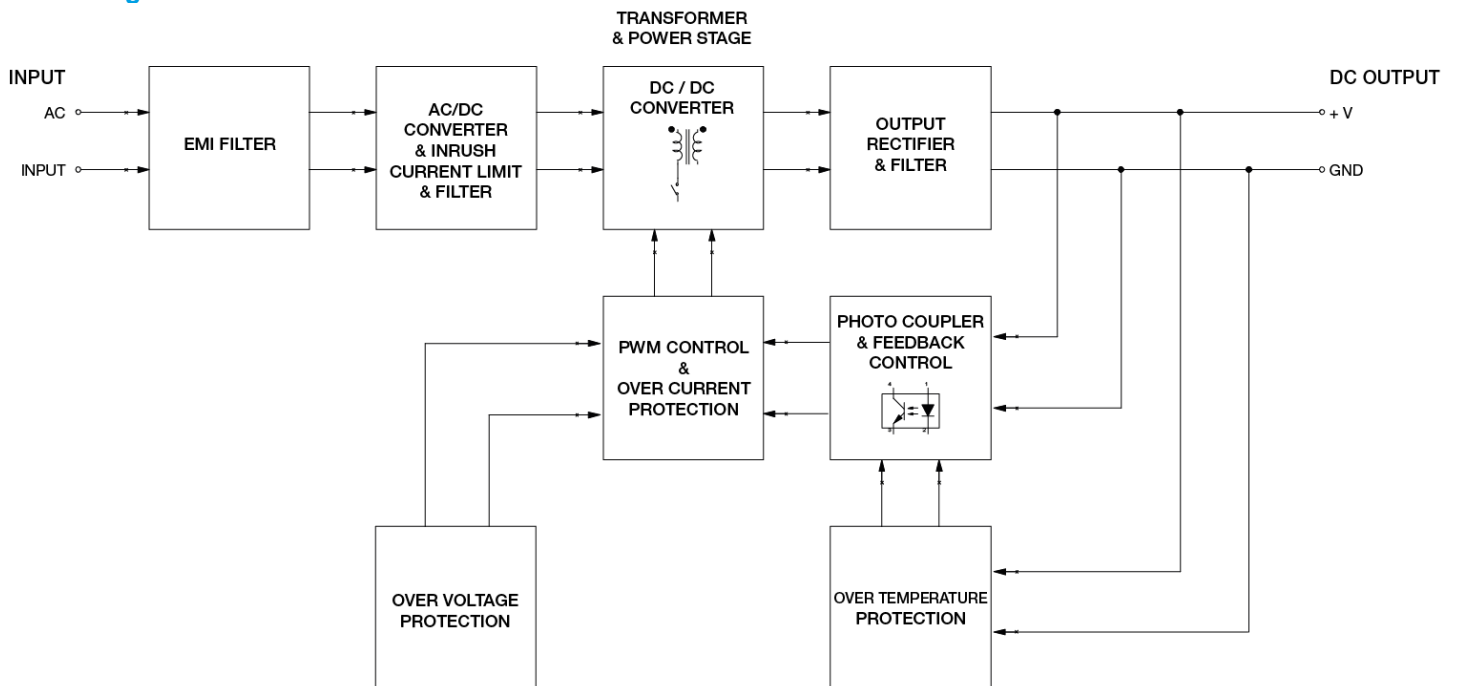

PJT Open Frame Power Supply

PJT-65W Series / PJT-□□V65WBAA

Dimensions

L x W x H: 101.6 x 50.8 x 30 mm [2" x 4"]

ø3.2 [0.126] (MOUNTING HOLE)
PE: MUST CONNECT WITH SYSTEM PROTECTIVE EARTHING

3-ø3.2 [0.126]
(MOUNTING HOLE)

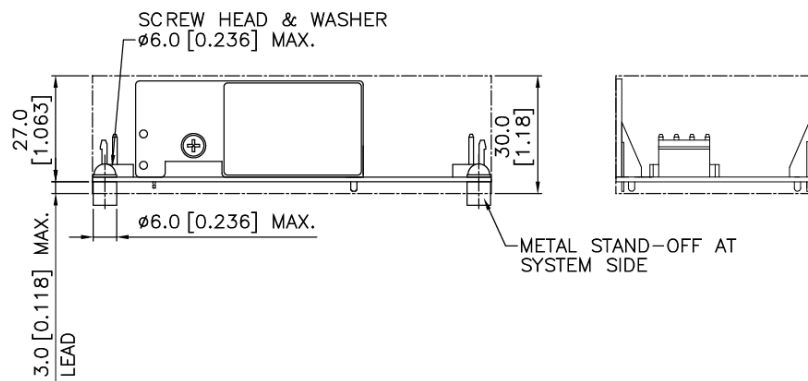
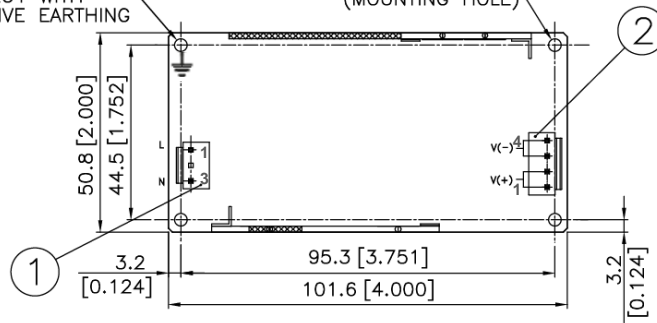

Item	Device Description
1	Input Connector (CN1) Pin 1: Line Pin 2: NC Pin 3: Neutral
2	Output Connector (CN2) Pin 1 to 2 : V(+) Pin 3 to 4 : V(-)

PJT Open Frame Power Supply

PJT-65W Series / PJT-□□V65WBAA

Engineering Data

Output Load De-rating VS Surrounding Air Temperature

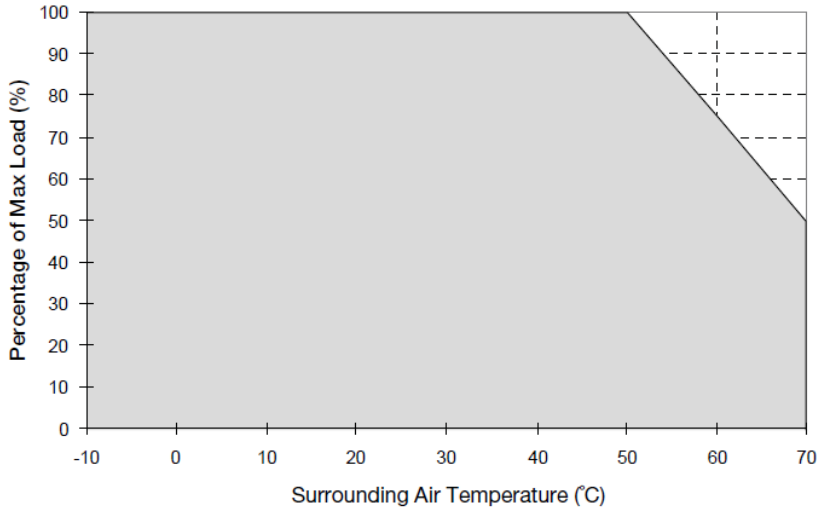
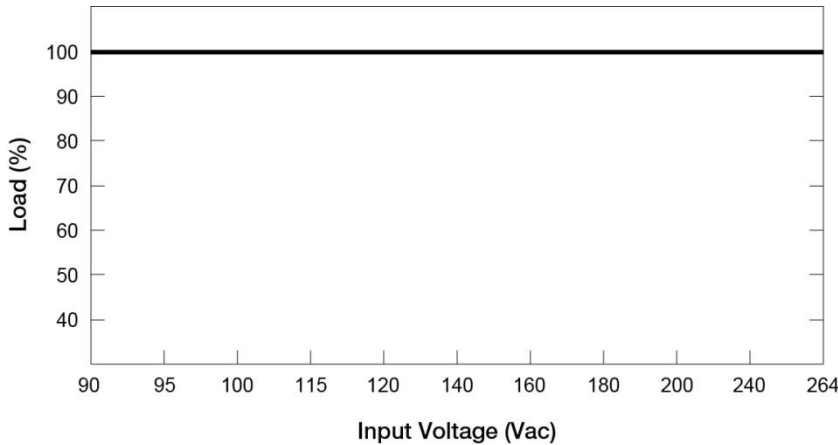

Fig. 1 De-rating for Horizontal Mounting Orientation
 > 50°C de-rate power by 2.5% / °C

Note

1. Power supply components may degrade, or be damaged, when the power supply is continuously used outside the shaded region, refer to the graph shown in Fig. 1.
2. If the output capacity is not reduced when the surrounding air temperature >50°C, the device will run into Over Temperature Protection. When activated, the output voltage will go into bouncing mode and will recover when the surrounding air temperature is lowered or the load is reduced as far as necessary to keep the device in working condition.
3. Depending on the surrounding air temperature and output load delivered by the power supply, the device can be very hot!
4. If the device has to be mounted in any other orientation, please leave a message via the [Contact Us](#) form.

Output Load De-rating VS Input Voltage



- No output power de-rating for the input voltage from 90 Vac to 264 Vac

PJT Open Frame Power Supply

PJT-65W Series / PJT-□□V65WBAA

Assembly & Installation

Any excessive twisting or bending may damage the device's PCB. Please handle the device with care.

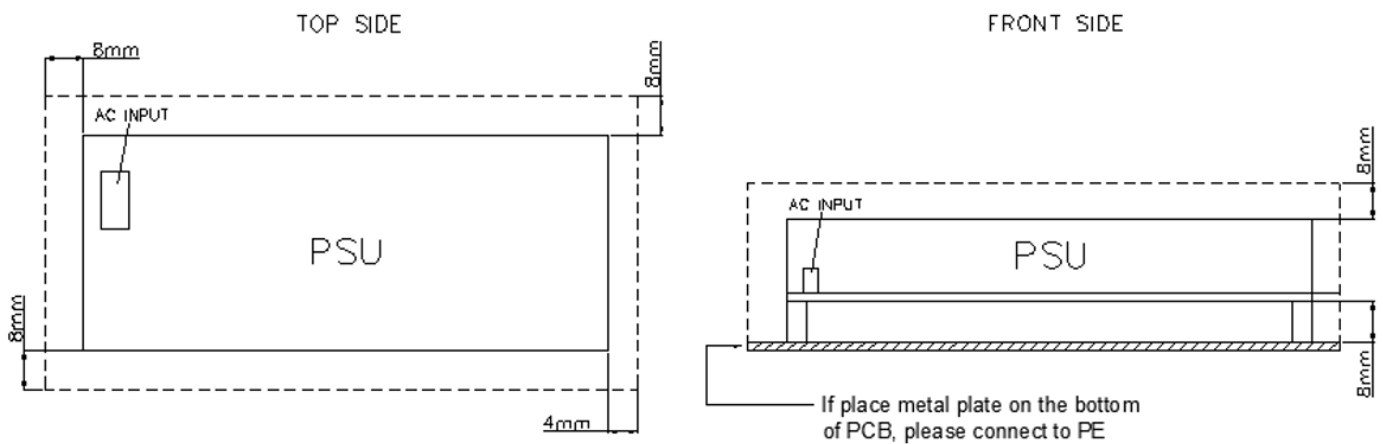
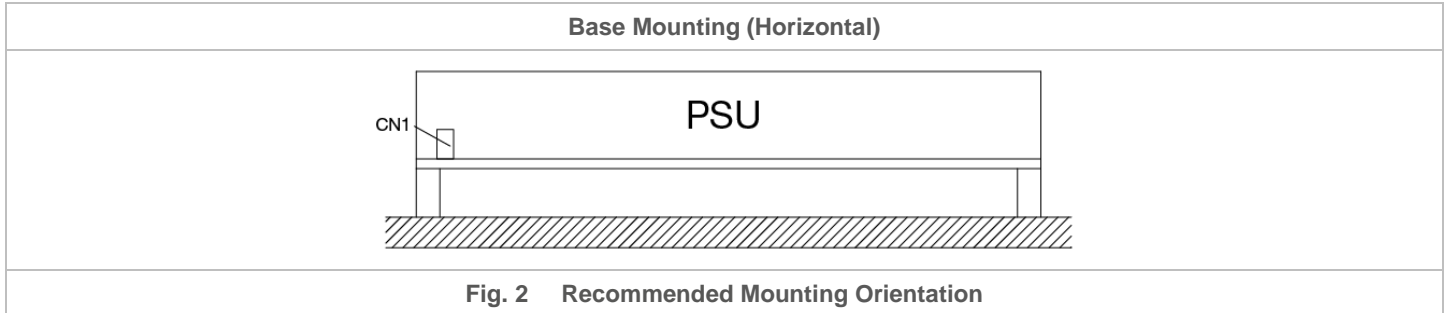

Use cable of AWG No. 22-18. Please refer to Table 1 for the recommended Mating Connector and Terminal.

Table 1	Input / Output	Power Supply Header	Mating Connector	Terminal
A – JST connector	Input	B2P3-VH (LF)(SN)	VHR-3N	SVH-21T-P1.1
	Output	B4P-VH (LF)(SN)	VHR-4N	SVH-21T-P1.1

Safety Instructions

- If the device has to be mounted in any other orientation, please leave a message via the [Contact Us](#) form.
- The device is not recommended to be placed on surface with low thermal conductivity, such as plastics, for example.
- For safety reasons, please ensure the mounted device is kept at ≥ 8 mm (0.315 inch) from primary side and ≥ 4 mm (0.16 inch) from secondary side safety distance from other components and equipments. Please insert an insulation sheet between the system and product, if the safety distance is less than 4 mm. In addition, to ensure sufficient convection cooling, always maintain a distance of ≥ 20 mm (0.79 inch) from ventilated surfaces while the device is in operation.
- Note that the device can become very hot depending on the ambient temperature and load of the power supply. Do not touch the device while it is in operation or immediately after power is turned OFF. Risk of burning!
- Do not touch the terminals while power is being supplied. Risk of electric shock.
- Prevent any foreign metal, particles or conductors from entering the device through the openings during installation. It may cause: Electric shock; Safety Hazard; Fire; Product failure
- The power supply must be mounted by metal screws onto a grounded metal surface. It is highly recommended that the Earth terminal on the connector be connected to the grounded metal surface.

PJT Open Frame Power Supply

PJT-65W Series / PJT-□□V65WBAA

Functions

Start-up Time

The time required for the output voltage to reach 90% of its final steady state set value, after the input voltage is applied.

Rise Time

The time required for the output voltage to change from 10% to 90% of its final steady state set value.

Hold-up Time

Time between the collapse of the AC input voltage, and the output falling to 95% of its steady state set value.

■ Graph illustrating the Start-up Time, Rise Time, and Hold-up Time

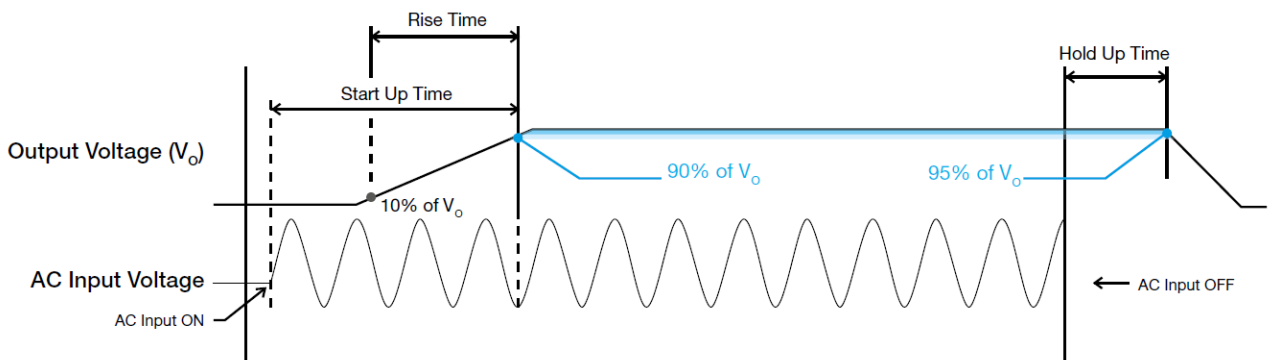

Inrush Current

Inrush current is the peak, instantaneous, input current measured and, occurs when the input voltage is first applied. For AC input voltages, the maximum peak value of inrush current will occur during the first half cycle of the applied AC voltage. This peak value decreases exponentially during subsequent cycles of AC voltage.

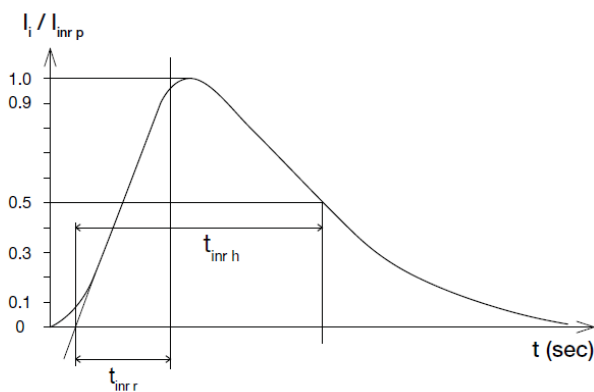

Dynamic Response

The power supply output voltage will remain within $\pm 5\%$ of its steady state value, when subjected to a dynamic load from 50 to 100% of its rated current.

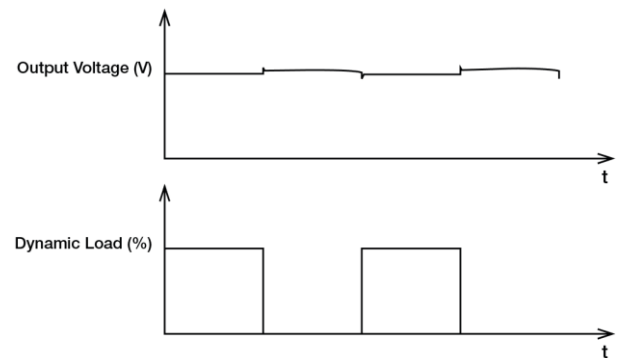

PJT Open Frame Power Supply

PJT-65W Series / PJT-□□V65WBAA

Overload & Overcurrent Protections (Auto-Recovery)

The power supply's Overload (OLP) and Overcurrent (OCP) Protections will be activated when output current exceeds 125% of I_o (Max load). In such occurrence, the V_o will start to droop and once the power supply has reached its maximum power limit, the protection is activated and the power supply will go into "Hiccup mode" (Auto-Recovery). The power supply will recover once the fault condition of the OLP and OCP is removed and I_o is back within the specifications.

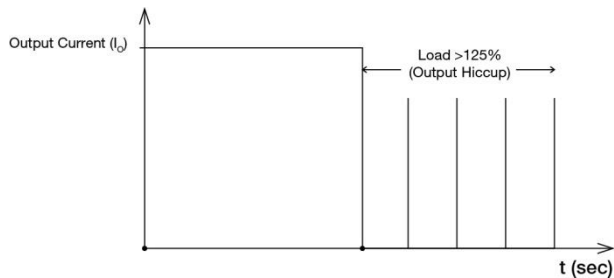

It is not recommended to prolong the duration of I_o when it is <125% but >100%, since it may cause damage to the PSU.

Short Circuit Protection (Auto-Recovery)

The power supply's output OLP/OCP function also provides protection against short circuits. When a short circuit is applied, the output current will operate in "Hiccup mode", as shown in the illustration in the OLP/OCP section on this page. The power supply will return to normal operation after the short circuit is removed.

Others

Attention

Delta provides all information in the datasheets on an "AS IS" basis and does not offer any kind of warranty through the information for using the product. In the event of any discrepancy between the information in the catalog and datasheets, the datasheets shall prevail (please refer to www.DeltaPSU.com for the latest datasheets information). Delta shall have no liability of indemnification for any claim or action arising from any error for the provided information in the datasheets. Customer shall take its responsibility for evaluation of using the product before placing an order with Delta.

Delta reserves the right to make changes to the information described in the datasheets without notice.

Manufacturer and Authorized Representatives Information

Manufacturer

Thailand
Delta Electronics (Thailand) PCL.
909 Pattana 1 Rd., Muang, Samutprakarn, 10280 Thailand

Taiwan
Delta Electronics, Inc.
3 Tungyuan Road, Chungli Industrial Zone, Taoyuan County
32063, Taiwan

Authorized Representatives

The Netherlands
Delta Greentech (Netherlands) B.V.
Zandsteen 15, 2132 MZ Hoofddorp, The Netherlands

United Kingdom
Delta Electronics Europe Limited
1 Redwood Court, Peel Park Campus,
East Kilbride, Glasgow, G74 5PF, United Kingdom

Overvoltage Protection (Latch Mode)

The power supply's overvoltage circuit will be activated when its internal feedback circuit fails. The output voltage shall not exceed its specifications defined on Page 3 under "Protections". Power supply will latch off, and require removal/re-application of input AC voltage in order to restart.

The power supply should be latch.

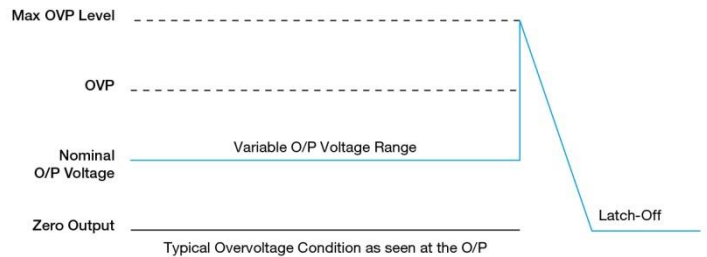

Over Temperature Protection (Auto-Recovery)

As described in load de-rating section, the power supply also has Over Temperature Protection (OTP). In the event of a higher operating temperature at 100% load, the power supply will run into OTP when the operating temperature is beyond what is recommended in the de-rating graph. When activated, the output voltage will go into bouncing mode until the temperature drops to its normal operating temperature as recommended in the de-rating graph.