





Medical Power Supplies



Medical Power Supplies

Open Frame Power Supplies

Series	Model Name	CC Code	Input Terminal	Output Terminal	Output				Dimensions (mm) (L x W x H)	
					Voltage	Convection		Forced Air		
Current	Power	Current	Power							
 <ul style="list-style-type: none"> Standard footprint offers versatile output and wattage 	MDS-040APS12B	A	JST B2P3-VH	JST B4P-VH	12 V	3.33 A	40 W	-	-	76.2 x 50.8 x 23
	MDS-065APS12B	A	JST B2P3-VH	JST B4P-VH		5.42 A	65 W	-	-	101.6 x 50.8 x 30
	MDS-100APS12B	A	JST B2P3-VH	JST B8P-VH		8.33 A	100 W	-	-	127 x 76.2 x 31
	MDS-100BPS12B	A	JST B2P3-VH	JST B4P-VH		6.67 A	80 W	8.33 A	100 W	101.6 x 50.8 x 31.8
	MDS-250APB12	AA	Molex 26-62-4030	M3 PCB terminal		12.5 A	150 W	20.84 A	250 W	127.3 x 76.5 x 36.6
		AB				12.5 A	150 W	20.84 A	250 W	127.3 x 76.5 x 36.6
	MDS-300APB12	AA	Molex 26-62-4030	M3 PCB terminal		18.33 A	220 W	25.0 A	300 W	127.3 x 76.5 x 36.6
	MDS-400APB12	AA	Molex 171813-9998	M3 PCB terminal		16.67 A	200 W	33.33 A	400 W	127.3 x 76.5 x 36.6
		AB			16.67 A	200 W	33.33 A	400 W	127.3 x 76.5 x 36.6	
	MDS-040APS15B	A	JST B2P3-VH	JST B4P-VH	15 V	2.67 A	40 W	-	-	76.2 x 50.8 x 23
	MDS-065APS15B	A	JST B2P3-VH	JST B4P-VH		4.2 A	65 W	-	-	101.6 x 50.8 x 30
	MDS-100APS15B	A	JST B2P3-VH	JST B8P-VH		6.67 A	100 W	-	-	127 x 76.2 x 31
	MDS-100BPS15B	A	JST B2P3-VH	JST B4P-VH		5.3 A	80 W	6.7 A	100 W	101.6 x 50.8 x 31.8
	MDS-040APS18B	A	JST B2P3-VH	JST B4P-VH	18 V	2.22 A	40 W	-	-	76.2 x 50.8 x 23
	MDS-065APS18B	A	JST B2P3-VH	JST B4P-VH		3.61 A	65 W	-	-	101.6 x 50.8 x 30
	MDS-100APS18B	A	JST B2P3-VH	JST B8P-VH		5.55 A	100 W	-	-	127 x 76.2 x 31
	MDS-100BPS18B	A	JST B2P3-VH	JST B4P-VH		4.4 A	80 W	5.5 A	100 W	101.6 x 50.8 x 31.8
	MDS-300APB18	AA	Molex 26-62-4030	M3 PCB terminal	12.22 A	220 W	16.66 A	300 W	127.3 x 76.5 x 36.6	
		AB			12.22 A	220 W	16.66 A	300 W	127.3 x 76.5 x 36.6	
	MDS-040APS24B	A	JST B2P3-VH	JST B4P-VH	24 V	1.67 A	40 W	-	-	76.2 x 50.8 x 23
	MDS-065APS24B	A	JST B2P3-VH	JST B4P-VH		2.71 A	65 W	-	-	101.6 x 50.8 x 30
	MDS-100APS24B	A	JST B2P3-VH	JST B8P-VH		4.17 A	100 W	-	-	127 x 76.2 x 31
	MDS-100BPS24B	A	JST B2P3-VH	JST B4P-VH		3.3 A	80 W	4.2 A	100 W	101.6 x 50.8 x 31.8
	MDS-250APB24	AA	Molex 26-62-4030	M3 PCB terminal		6.25 A	150 W	10.41 A	250 W	127.3 x 76.5 x 36.6
		AB				6.25 A	150 W	10.41 A	250 W	127.3 x 76.5 x 36.6
	MDS-300APB24	AA	Molex 26-62-4030	M3 PCB terminal		10.0 A	240 W	12.5 A	300 W	127.3 x 76.5 x 36.6
		AE				10.0 A	240 W	12.5 A	300 W	127.3 x 76.5 x 36.6
	MDS-400APB24	AA	Molex 171813-9998	M3 PCB terminal	8.33 A	200 W	16.66 A	400 W	127.3 x 76.5 x 36.6	
AB		8.33 A			200 W	16.66 A	400 W	127.3 x 76.5 x 36.6		
MDS-200APB36	AA	Molex 171813-9998	JST B4P-VH	36 V	3.33 A	120 W	5.56 A	200 W	101.9 x 51.1 x 36.6	
MDS-300APB48	AA	Molex 26-62-4030	M3 PCB terminal	48 V	5.0 A	240 W	6.25 A	300 W	127.3 x 76.5 x 36.6	
	AB			5.0 A	240 W	6.25 A	300 W	127.3 x 76.5 x 36.6		
 <ul style="list-style-type: none"> High power density in a small footprint and low profile 	MEP-120A12J	BNA	JST B2P3-VH	JST B4P-VH	12 V	9.5 A	114 W	-	-	76.2 x 50.8 x 31
	MEP-200A12J	BNA	JST B2P3-VH	JST B6P-VH-B		16.67 A*	200 W*	16.67 A	200 W	101.6 x 50.8 x 28.5
	NEW MEP-500A12J	BRA	JST B2P3-VH	M4 PCB terminal	25.0 A	300 W	41.7 A	500 W	127 x 76.2 x 33.1	
	MEP-25A15J	BNA	JST B2P3-VH	JST B4P-VH	15 V	1.67 A	25 W	-	-	76.2 x 50.8 x 23
	MEP-120A15J	BNA	JST B2P3-VH	JST B4P-VH		8.0 A	120 W	-	-	76.2 x 50.8 x 31
	MEP-120A18J	BNA	JST B2P3-VH	JST B4P-VH	18 V	6.67 A	120 W	-	-	76.2 x 50.8 x 31
	NEW MEP-500A18J	BRA	JST B2P3-VH	M4 PCB terminal		16.7 A	300 W	27.8 A	500 W	127 x 76.2 x 33.1
	MEP-120A24J	BNA	JST B2P3-VH	JST B4P-VH	24 V	5.0 A	120 W	-	-	76.2 x 50.8 x 31
	MEP-200A24J	BNA	JST B2P3-VH	JST B6P-VH-B		8.34 A*	200 W*	8.34 A	200 W	101.6 x 50.8 x 28.5
	NEW MEP-500A24J	BRA	JST B2P3-VH	M4 PCB terminal		12.5 A	300 W	20.9 A	501 W	127 x 76.2 x 33.1
	NEW MEP-600A24J	BRA	JST B2P3-VH	M4 PCB terminal		18.75 A	450 W	25.0 A	600 W	127 x 76.2 x 39
	MEP-200A48J	BNA	JST B2P3-VH	JST B6P-VH-B	48 V	4.17 A*	200 W*	4.17 A	200 W	101.6 x 50.8 x 28.5
NEW MEP-500A48J	BRA	JST B2P3-VH	M4 PCB terminal	6.25 A		300 W	10.5 A	504 W	127 x 76.2 x 33.1	
 <ul style="list-style-type: none"> U-Frame outline offers convection or forced air cooling 	MEU-650A12T	AAA	DG128-75-03P-14-1001A(H)	M4 PCB terminal	12 V	33.4 A	400 W	50.0 A	600 W	152.4 x 101.6 x 40
	MEU-600C24T	AAA	Anytek YK4020323200G	M5 PCB terminal	24 V	25.0 A	600 W	-	-	203.2 x 127 x 40
	MEU-650A24T	AAA	DG128-75-03P-14-1001A(H)	M4 PCB terminal		18.75 A	450 W	27.1 A	650 W	152.4 x 101.6 x 40
	MEU-600C48T	AAA	Anytek YK4020323200G	M5 PCB terminal	48 V	12.5 A	600 W	-	-	203.2 x 127 x 40
	MEU-650A48T	AAA	DG128-75-03P-14-1001A(H)	M4 PCB terminal		9.375 A	450 W	13.6 A	650 W	152.4 x 101.6 x 40

*Refer to technical datasheet

Enclosed Power Supplies

Series	Model Name	CC Code	Input Terminal	Output Terminal	Output				Dimensions (mm) (L x W x H)	
					Voltage	Convection		Forced Air		
						Current	Power	Current		Power
MDS  • General use for medical application	MDS-250ADB12	AA	Molex 26-62-4030	M3 PCB terminal	12 V	11.25 A	135 W	20.84 A	250 W	140 × 88.9 × 44.4
	MDS-250ADB12	AB				11.25 A	135 W	20.84 A	250 W	140 × 88.9 × 44.4
	MDS-300ADB12	AA				15.83 A	190 W	25.0 A	300 W	140 × 88.9 × 44.4
	MDS-400ADB12	AA	Molex 171813-9998	M3 PCB terminal	18 V	-	-	33.33 A	400 W	140 × 88.9 × 44.4
	MDS-300ADB18	AA	Molex 26-62-4030	M3 PCB terminal		10.55 A	190 W	16.66 A	300 W	140 × 88.9 × 44.4
	MDS-300ADB18	AB	10.55 A	190 W		16.66 A	300 W	140 × 88.9 × 44.4		
	MDS-250ADB24	AA	Molex 171813-9998	M3 PCB terminal	24 V	5.62 A	135 W	10.41 A	250 W	140 × 88.9 × 44.4
	MDS-300ADB24	AA	Molex 26-62-4030	M3 PCB terminal		8.75 A	210 W	12.5 A	300 W	140 × 88.9 × 44.4
	MDS-300ADB24	AB	8.75 A	210 W		12.5 A	300 W	140 × 88.9 × 44.4		
	MDS-400ADB24	AA	Molex 171813-9998	M3 PCB terminal		-	-	16.67 A	400 W	140 × 88.9 × 44.4
	MDS-400ADB24	AB	171813-9998	M3 PCB terminal	-	-	16.67 A	400 W	140 × 88.9 × 44.4	
	MDS-300ADB48	AA	Molex 26-62-4030	M3 PCB terminal	48 V	4.375 A	210 W	6.25 A	300 W	140 × 88.9 × 44.4
MDS-300ADB48	AB	4.375 A	210 W	6.25 A		300 W	140 × 88.9 × 44.4			
MEP  • High power density in a small footprint and low profile	MEP-200A12J	CNA	JST B2P3-VH	JST B6P-VH-B	12 V	16.67 A*	200 W*	16.67 A	200 W	111.2 × 62.8 × 32.5
	MEP-500A12J	CRA DRA	JST B2P3-VH	M4 PCB terminal		25.0A	300W	41.7A	500 W	138.6 × 88.2 × 38.4
	MEP-500A18J	CRA DRA	JST B2P3-VH	M4 PCB terminal	18 V	16.7 A	300 W	27.8 A	500 W	138.6 × 88.2 × 38.4
	MEP-200A24J	CNA	JST B2P3-VH	JST B6P-VH-B		8.34 A*	200 W*	8.34 A	200 W	111.2 × 62.8 × 32.5
	MEP-500A24J	CRA DRA	JST B2P3-VH	M4 PCB terminal	24 V	12.5A	300W	20.9A	501W	138.6 × 88.2 × 38.4
	MEP-200A48J	CNA	JST B2P3-VH	JST B6P-VH-B		4.17 A*	200 W*	4.17 A	200 W	111.2 × 62.8 × 32.5
	MEP-500A48J	CRA DRA	JST B2P3-VH	M4 PCB terminal	48 V	6.25 A	300 W	10.5 A	504 W	138.6 × 88.2 × 38.4
	MEP-500A48J	CRA DRA	JST B2P3-VH	M4 PCB terminal		-	-	10.5 A	504 W	138.6 × 88.2 × 38.4
MEB  • Intelligent fan speed control	MEB-750A12B	AAA	TU-301-SP-SA-AD2(D)V0	M5 PCB terminal	12 V	-	-	58.4 A	700 W	177.8 × 101.6 × 40
	MEB-750A12T	AAA	Dinkle DT-2G-B95W-03	M5 PCB terminal		-	-	58.4 A	700 W	177.8 × 101.6 × 40
	MEB-500A24F	AA	Deca T24-EO3103A302	Deca DT-65-C14W-02	24 V	-	-	21.0 A	500 W	165.3 × 85.2 × 41
	MEB-750A24B	AAA	TU-301-SP-SA-AD2(D)V0	M5 PCB terminal		-	-	31.25 A	750 W	177.8 × 101.6 × 40
	MEB-750A24T	AAA	Dinkle DT-2G-B95W-03	M5 PCB terminal		-	-	31.25 A	750 W	177.8 × 101.6 × 40
	MEB-1K2A24T	ABA	Anytek YK50A0323009G	M5 PCB terminal		-	-	50.0 A	1,200 W	204 × 127 × 40.5
	MEB-1K5A24T	AAA	Deca T25-E03H03	Anytek YK50A0423009G		-	-	60.0 A	1,500 W	204 × 127 × 40.5
	MEB-2K5A24T	NAA	Anytek YK50A0323009G	Busbar		-	-	104.2 A	2,500 W	267.5 × 127 × 40.5
	MEB-2K5A24T	RAA	YK50A0323009G	Busbar		-	-	104.2 A	2,500 W	267.5 × 127 × 40.5
	MEB-2K5A36T	NAA	Anytek YK50A0323009G	Busbar		36 V	-	-	69.5 A	2,500 W
	MEB-2K5A36T	RAA	YK50A0323009G	Busbar	-		-	69.5 A	2,500 W	267.5 × 127 × 40.5
	MEB-1K2A42T	ABA	Anytek YK50A0323009G	M5 PCB terminal	42 V	-	-	28.5 A	1,200 W	204 × 127 × 40.5
	MEB-750A48B	AAA	TU-301-SP-SA-AD2(D)V0	M5 PCB terminal	48 V	-	-	15.63 A	750 W	177.8 × 101.6 × 40
	MEB-750A48T	AAA	Dinkle DT-2G-B95W-03	M5 PCB terminal		-	-	15.63 A	750 W	177.8 × 101.6 × 40
	MEB-1K2A48T	ABA	Anytek YK50A0323009G	M5 PCB terminal		-	-	25.0 A	1,200 W	204 × 127 × 40.5
MEB-1K5A48T	AAA	Deca T25-E03H03	Anytek YK50A0423009G	-		-	31.25 A	1,500 W	204 × 127 × 40.5	
MEB-2K5A48T	NAA	Anytek YK50A0323009G	Busbar	-		-	52.1 A	2,500 W	310.8 × 127 × 40.5	
MEB-2K5A48T	RAA	YK50A0323009G	Busbar	-		-	52.1 A	2,500 W	310.8 × 127 × 40.5	

*Refer to technical datasheet

ATX Power Supply

Series	Model Name	CC Code	Input Terminal	Output Terminal	Output		Output Power	Dimensions (mm) (L x W x H)
					Voltage	Current		
 <ul style="list-style-type: none"> ATX power supply with built-in fan cooling 	MDS-350AD701	AA	C14	Wire harness	+3.3 V, +5 V, +5 V _{SB} , +12 V ₁ , +12 V ₂ , -12 V, -5 V	8.0 A, 9.0 A, 1.25 A, 8.0 A, 8.0 A, 0.25 A, 0.1 A	350 W	194 × 100 × 40.5

Adapters

Series	Model Name	CC Code	Output			Dimensions (mm) (L x W x H)
			Voltage	Current	Power	
 <ul style="list-style-type: none"> General adapter for medical application 	MDS-005AAS05	AU	5 V	1.0 A	5 W	56.5 × 39.5 × 28
		AV		1.0 A	5 W	56.5 × 39.5 × 28
		BU		1.0 A	5 W	56.5 × 39.5 × 28
		BV		1.0 A	5 W	56.5 × 39.5 × 28
		CU		1.0 A	5 W	56.5 × 39.5 × 28
		CV		1.0 A	5 W	56.5 × 39.5 × 28
	MDS-030AAC05	AA	3.0 A	15 W	88 × 53.5 × 27.5	
		AB	3.0 A	15 W	88 × 53.5 × 27.5	
	MDS-030AAC12	AC	3.0 A	15 W	88 × 53.5 × 27.5	
		AA	2.0 A	24 W	88 × 53.5 × 27.5	
		AB	2.0 A	24 W	88 × 53.5 × 27.5	
		AC	2.0 A	24 W	88 × 53.5 × 27.5	
	MDS-030AAC15	BB	2.0 A	24 W	88 × 53.5 × 27.5	
		AA	2.0 A	30 W	88 × 53.5 × 27.5	
		AB	2.0 A	30 W	88 × 53.5 × 27.5	
		AC	2.0 A	30 W	88 × 53.5 × 27.5	
MDS-030AAC24	BC	2.0 A	30 W	88 × 53.5 × 27.5		
	BD	2.0 A	30 W	88 × 53.5 × 27.5		
	AA	1.25 A	30 W	56.5 × 39.5 × 28		
	AB	1.25 A	30 W	56.5 × 39.5 × 28		
MDS-090BAS24	AC	1.25 A	30 W	56.5 × 39.5 × 28		
	AB	3.75 A	90 W	150 × 75 × 40		
 <ul style="list-style-type: none"> New generation adapter with compact size and high power density design 	MEA-065A12C	A-A	12 V	5.0 A	60 W	115 × 50 × 29
		6-A		5.0 A	60 W	115 × 50 × 29
		V-A		5.0 A	60 W	115 × 50 × 29
	NEW MEA-065A12B	A-A		5.0 A	60 W	120 × 50 × 32
		6-A		6.75 A	81 W	135 × 62 × 32
	MEA-090A12C	V-A		6.75 A	81 W	135 × 62 × 32
		W-A	6.75 A	81 W	135 × 62 × 32	
		NEW MEA-160A12C	GAA	12.5 A	150 W	150 × 65 × 32
	NEW MEA-065A15C	A-A	4.33 A	65 W	115 × 50 × 29	
		A-A	4.33 A	65 W	120 × 50 × 32	
		6-A	6.0 A	90 W	135 × 62 × 32	
	MEA-090A15C	V-A	6.0 A	90 W	135 × 62 × 32	
		W-A	6.0 A	90 W	135 × 62 × 32	
		NEW MEA-160A15C	GAA	10.67 A	160 W	150 × 65 × 32
	MEA-065A19C	A-A	3.42 A	65 W	115 × 50 × 29	
		V-A	3.42 A	65 W	115 × 50 × 29	
		NEW MEA-065A19B	A-A	3.42 A	65 W	120 × 50 × 32
	MEA-090A19C	6-A	4.74 A	90 W	135 × 62 × 32	
		V-A	4.74 A	90 W	135 × 62 × 32	
		NEW MEA-160A19C	GAA	8.42 A	160 W	150 × 65 × 32
	MEA-065A24C	A-A	2.71 A	65 W	115 × 50 × 29	
		6-A	2.71 A	65 W	115 × 50 × 29	
		NEW MEA-065A24B	A-A	2.71 A	65 W	120 × 50 × 32
	MEA-090A24C	6-A	3.75 A	90 W	135 × 62 × 32	
		V-A	3.75 A	90 W	135 × 62 × 32	
		NEW MEA-160A24C	GAA	6.67 A	160 W	150 × 65 × 32
NEW MEA-250A24C	H-A	10.42 A	250 W	200 × 100 × 43		
	NEW MEA-300A24C	HAA	12.5 A	300 W	200 × 100 × 43	

Configurable Power Supplies

Delta has leveraged its rich development and manufacturing experience to develop the MEG-A Series AC-DC configurable power supplies. Their flexible modular design, 2V to 60V adjustable output voltage, and multiple sets of output power combinations make it possible for different configurations to satisfy different equipment requirements while also saving on space. With these power supplies, outputs can be monitored and adjusted accurately via various digital communication interfaces. Their intelligent and flexible design mean that all of your needs can be met.

Applications



X-Ray



CT Scan



IVD



Ultrasound



Da Vinci Robot

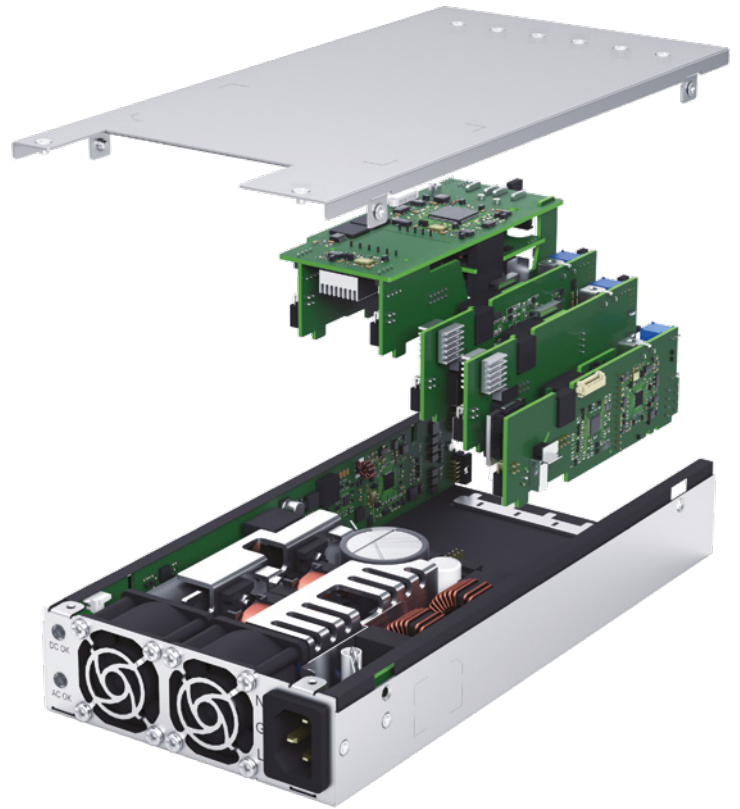

Models



MEG-700A3
(3 slots)



MEG-1K2A4
(4 slots)



MEG-2K1A6
(6 slots)



MEG-3K0A9
(9 slots)

Output Modules

• Single Output Module



Single Slot
(Max. 300 W output)

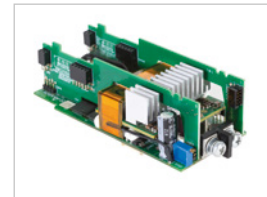

Triple Slot
(Max. 1,200 W output)

• Dual Output Module



Single Slot
(Max. 240 W output)

Series	Model Name	Output Slots	Output Voltage	Output Power	Dimensions (mm) (L x W x H)
MEG-A • Configurable power supplies with flexible modular design and adjustable output voltage range from 2-60V	MEG-700A3	3 slots	Single Output Single slot: 2 V - 60 V Triple slot: 8 V - 60 V	700 W	215 × 88.9 × 41.5
	MEG-1K2A4	4 slots		1,200 W	254 × 88.9 × 40.5
	MEG-2K1A6	6 slots	Dual Output Single slot: 3.3 V - 30 V	2,100 W	254 × 127 × 40.5
	MEG-3K0A9	9 slots		3,000 W	254 × 181 × 40.5



Configure Your Power Supply

<https://psu.deltaww.com/en/tools/configurable-product-selection>

Global Operation & Service

Asia

Delta Electronics, Inc.

3 Tungyuan Road, Chungli Industrial Zone,
Taoyuan County 32063, Taiwan, R.O.C.

TEL: +886 3 452 6107
FAX: +886 3 452 7314

Delta Electronics (Shanghai) Co., Ltd China Headquarters

No. 182 Minyu Road, Pudong,
Shanghai, P.R.C. 201209

TEL: +86 21 6872 3988
FAX: +86 21 6872 3996

Delta Electronics (Thailand) PCL.

909 Soi 9, Moo 4, Bangpoo Industrial Estate
(E.P.Z.), Pattana 1 Rd., T. Phrakasa, A. Muang,
Samutprakarn 10280, Thailand

TEL: +66 2 709 2800
FAX: +66 2 709 2827

Delta Electronics India Pvt. Ltd.

Plot No. 43, Sector - 35, HSIIDC,
Gurgaon, Haryana 122001

TEL: +91 124 4874 900
+91 124 4169 040
FAX: +91 124 4874 945

Delta Electronics (Japan), Inc.

4-11-25 Shibaura, Minato-ku,
Tokyo, 108-0023, Japan

TEL: +81 3 6811 5800
FAX: +81 3 6811 5802

Delta Electronics (Korea), Inc.

1504, Byucksan Digital Valley 6-Cha,
Gasan-dong, Geumcheon-gu, Seoul,
153-704, Korea

TEL: +82 2 515 5303
+82 2 515 5305
FAX: +82 2 515 5302

Delta Electronics (Australia) Pty Ltd

20-21, 45 Normanby Rd.
Nothing Hill, VIC 3168, Australia

TEL: +61 9543 3720
FAX: +61 9544 0606

Delta Energy Systems (Singapore) Pte Ltd

4 Kaki Bukit Avenue 1
#05-04, Singapore 417939

TEL: +65 6747 5155
FAX: +65 6744 9228

North America

Delta Electronics (Americas) Ltd. North American Headquarters

46101 Fremont Blvd.
Fremont, CA 94538, U.S.A.

TEL: +1 510 668 5100
FAX: +1 510 668 0680

Central & South America

Delta Electronics International Mexico S.A. de C.V.

Centrum Park, Av. Gustavo Baz Prada 309
Edificio E Planta Baja, Col. La Loma, C.P.

54030 Tlalnepantla, Estado de México
TEL: +52 55 3603 9200

Delta Electronics (Brasil) Ltda

Estrada Velha Rio São Paulo, 5300-
Eugênio de Melo, 12247-001-São José dos
Campos-SP- Brasil

TEL: +55 12 3932 2300

Europe

Delta Electronics (Netherlands) B.V. EMEA Headquarters

Zandsteen 15
2132 MZ Hoofddorp, The Netherlands

TEL: +31 20 800 3900

Automotive Campus 260
5708 JZ Helmond, The Netherlands

TEL: +31 40 800 3900

Delta Greentech Elektronik (Turkey)

Şerifali Mah. Hendem Cad. Kule Sok. No: 16-A,
Ümraniye, İstanbul, Turkey

TEL: +90 216 499 99 10
FAX: +90 216 499 80 70



PSU.deltaww.com

January 2026 (Rev. 01) - All information and specifications are subjected to change without prior notice.