

# LED Driver

## EUCI LITE Series



# EUCI LITE

### Highlights & Features

- DALI-2 certified LED driver, 5%-100 % dimming range
- Flexible configurable operating windows (AOC) via NFC, DALI
- Robustness protection against vibration, harsh operating temperature and moisture
- Autonomous dimming includes three “Smart Timer Dim” operation modes with five independent levels: Fixed Timer, Midnight Centric Timer, and Ratio Rescale Timer
- Override function is used to force the output dimming to maximum in any of Smart Timer Dim modes at any given time when AC mains are shorted to DALI port
- High Efficiency (Up to 90%)
- High surge immunity
- Design and fix for luminaires of protection class I and protection class II

### Safety Standards



### Dimensions (L x W x H):

EUCI-022105GLB	133.0 x 77.0 x 40.0 mm (5.24 x 3.00 x 1.57 inch)
EUCI-040105GLB	133.0 x 77.0 x 40.0 mm (5.24 x 3.00 x 1.57 inch)
EUCI-075105GLB	133.0 x 77.0 x 40.0 mm (5.24 x 3.00 x 1.57 inch)
EUCI-130105GLB1	150.0 x 90.0 x 40.0 mm (5.91 x 3.54 x 1.57 inch)
EUCI-170105GLB1	170.0 x 100.0 x 40.0 mm (6.69 x 3.94 x 1.57 inch)

### General Description

Delta LED drivers come in different series to suit different application needs. The EUCI LITE series features program output current level. EUCI LITE series offers the capability to achieve different level of LED brightness via built-in DALI-2 function to meet various application and energy optimization needs. The products are designed and rigorously tested to work with various outdoor LED lighting conditions. Featuring high surge immunity (CM: 10kV, DM: 6kV) make Delta EUCI LITE series an essential part of an energy efficient LED lighting power solution for both Industrial and outdoor applications.

### Model Information

#### EUCI LITE LED Driver

Model Number	Input Voltage Range	Rated Output Voltage	Program Output Current Range	Constant Power Current Range
EUCI-022105GLB	220-240Vac Typical 198-264Vac Range	8-48Vdc	200-1050mA	460-1050mA
EUCI-040105GLB		20-77Vdc	200-1050mA	520-1050mA
EUCI-075105GLB		35-150Vdc	200-1050mA	500-1050mA
EUCI-130105GLB1		60-200Vdc	200-1050mA	650-1050mA
EUCI-170105GLB1		80-310Vdc	200-1050mA	550-1050mA

### Model Numbering

EU	C	I	-	□□□	□□□	G	L	B
Safety Approval CE, ENEC	Constant current	Industrial		Output Power 022-22W 040-40W 075-75W 130-130W 170-170W	Output Current 105-1050mA	Programmable output current	Control type DALI-2	B Standard

# LED Driver

## EUCI LITE Series

### Specifications

Model Number	EUCI-022105GLB	EUCI-040105GLB	EUCI-075105GLB	EUCI-130105GLB1	EUCI-170105GLB1
--------------	----------------	----------------	----------------	-----------------	-----------------

### Input Ratings / Characteristics

Normal Input Voltage	220-240Vac					
Input Voltage Range	198-264Vac					
Normal Input Frequency	50-60Hz					
Input Frequency Range	47-63Hz					
Max. Input Current	230Vac	0.12A	0.23A	0.43A	0.67A	0.8A
Efficiency <sup>1)</sup>	230Vac	90% @ 0.46A	90% @ 0.52 A	92% @ 0.5A	93% @ 0.7A	93% @ 0.7A
	230Vac	86% @ 1.05A	87% @ 1.05A	90% @ 1.05A	92% @ 1.05A	92% @ 1.05A
Inrush Current (Apk / 50%-us) (Cold Start)	230Vac	20A/250uS	20A/250uS	20A/250uS	10A/250uS	10A/250uS
Max. No. of LED Drivers circuit breaker @ 230Vac	B10	18pcs	18pcs	15pcs	10pcs	8pcs
	B16	28pcs	28pcs	25pcs	15pcs	14pcs
	C10	30pcs	30pcs	15pcs	10pcs	8pcs
	C16	46pcs	46pcs	25pcs	15pcs	14pcs
Power Factor	> 0.95 @ 230Vac, 100% load					
Total Harmonic Distortion	< 20% @ 230Vac, 100% load					
Leakage Current	< 0.7mA peak @ 230Vac					
Standby Power	0.5W @ DALI standby mode, 230Vac					
Input Over-Voltage	Can survive input over-voltage stress of 320VAC for 48 hours and 350Vac for 2 hours					

### Output Ratings / Characteristics

Output Voltage Range	8-48Vdc	20-77Vdc	35-150Vdc	60-200Vdc	80-310Vdc
Max. No Load Output Voltage	90V	120V	210V	250V	350V
Output Power Range	22W	40W	75W	130W	170W
Adjustable Output Current (AOC)	200-1050mA	200-1050mA	200-1050mA	200-1050mA	200-1050mA
	With steps of 1mA, configurable via software				
Physical Minimum Output Current	35mA (Min dim level)				
Current Accuracy	± 5%	± 5%	± 5%	± 5%	± 5%
	@ 0.46~1.05A	@ 0.52A~1.05A	@ 0.5A~1.05A	@ 0.65A~1.05A	@ 0.55A~1.05A
Line Regulation	± 3% (@ 220-240Vac)				
Load Regulation	± 5% (@ Min-Max output voltage)				
Output Current LF Ripple	4% (ripple = peak-average/average) at full load, (<100Hz)				
Start-up Time	520~1000ms max. (@ 220-240Vac)				

# LED Driver

## EUCI LITE Series

Model Number	EUCI-022105GLB	EUCI-040105GLB	EUCI-075105GLB	EUCI-130105GLB1	EUCI-170105GLB1
--------------	----------------	----------------	----------------	-----------------	-----------------

### Mechanical

Casing	Plastic, Color : Black				
Dimensions (L x W x H)	[mm]	133.0 x 77.0 x 40.0		150.0 x 90.0 x 40.0	170.0x100.0x40.0
	[inch]	5.24 x 3.03 x 1.57		5.91 x 3.54 x1.57	6.69 x 3.94 x 1.57
Unit Weight	[kg]	0.55		0.75	0.98
	[lb]	1.20		1.65	2.16
Weight/carton	[kg]	11.4		8	10.3
Pieces per carton box		20pcs	20pcs	20pcs	10pcs
Cooling System	Convection				
Input connector(22/40/75W)	Terminal, 5-pole, Conductor 0.5~2.5 mm <sup>2</sup> , Strip length 10...11mm Line : Black, Neutral : White, Space*2 : Gray, EUQI : Green				
Input connector(130/170W)	Terminal, 2-pole, Conductor 0.5~2.5 mm <sup>2</sup> , Strip length 10...11mm Line : Black, Neutral : White				
Output connector(22/40/75W)	Terminal, 6-pole, Conductor 0.5~1.5 mm <sup>2</sup> , Strip length 8.5...9.5mm LED+ : Red, LED- : Black, GND : White, MTP : Light blue, DALI*2 : Blue				
Output connector(130/170W)	Terminal, 8-pole, Conductor 0.5~1.5 mm <sup>2</sup> , Strip length 8.5...9.5mm Gray (DALI*2/Spacer/EUQI/Spacer*2 / NTC/GND/Rset/LED+/LED-)				
Max cable length	2m (between driver and LED module)				
Noise (30cm distance)	Sound Pressure Level (SPL) < 24dBA				

### Environment

Ambient Temperature	Operating	-40°C to +55°C			
	Storage	-40°C to +85°C			
Maximum Case Temperature		+85°C	+90°C	+90°C	+85°C
Lifetime @ tc		+85°C	+90°C	+90°C	+85°C
Relative Humidity	Operating	10 to 90% RH (Non-Condensing)			
	Storage	5 to 95% RH (Non-Condensing)			

### Protections

Over Voltage	90Vrms	120Vrms	210Vrms	250Vrms	360Vrms
	Luminaries will work normally when the fault is removed				
Overload / Overcurrent	Reduce output current. Auto-Recovery when the fault is removed				
Short Circuit	Auto-Recovery when the fault is removed				
Over Temperature	Reduce output current. Auto-Recovery when the fault is removed				
Ingress Protection Classification	IP20				
Suitable for Luminaires Class	Class I/Class II. Insulation Class according to IEC 60598				

### Reliability Data

Lifetime	50,000 hours @ lifetime case temperature
MTTF	1,000,000 hours for 22W/40W, 830,000 hours for 75W
	690,000 hours for 130W, 475,000 hours for 170W @Ta=+55°C (as per Telcordia SR-332, total failure rate less than10%)

# LED Driver

## EUCI LITE Series

<b>Model Number</b>	EUCI-022105GLB	EUCI-040105GLB	EUCI-075105GLB	EUCI-130105GLB1	EUCI-170105GLB1
---------------------	----------------	----------------	----------------	-----------------	-----------------

### Safety Standards / Directives

Electrical Safety	IEC 61347-1, IEC 61347-2-13 (Built in) EN 61347-1, EN 61347-2-13 SELV (for22W/40W)			
CE	In conformance with EMC Directive and Low Voltage Directive			
Material and Parts	RoHS Directive 2011/65/EU Compliant			
Galvanic Isolation (20/40/75W)	Mains	EQUI	LED+MTP	DALI
Mains	N/A	Double	Double	Basic
EQUI	Double	N/A	Basic	Supplementary
LED+MTP	Double	Basic	N/A	Supplementary
DALI	Basic	Supplementary	Supplementary	N/A
Galvanic Isolation (130/170W)	Mains	EQUI	LED+NTC	DALI
Mains	N/A	Double	Double	Basic
EQUI	Double	N/A	Double	Double
LED+NTC	Double	Double	N/A	Double
DALI	Basic	Double	Double	N/A

### EMC

Emissions (CE & RE)	Compliance to EN 55015 Class B;	
Immunity	Compliance to EN 61547	
Electrostatic Discharge	IEC 61000-4-2	Air Discharge: 8kV Contact Discharge: 4kV Criteria A <sup>1)</sup> or Criteria B <sup>2)</sup>
Radiated Disturbances	IEC 61000-4-3	80MHz-1GHz, 3V/m with 1kHz Sine Wave / 80% Modulation Criteria A <sup>1)</sup>
Electrical Fast Transient / Burst	IEC 61000-4-4	1KV, Criteria A <sup>1)</sup> or Criteria B <sup>2)</sup>
Surge	IEC 61000-4-5	Common Mode <sup>3)</sup> : 10kV; Differential Mode <sup>4)</sup> : 6kV, Criteria A <sup>1)</sup> or Criteria B <sup>2)</sup>
Conducted Disturbances	IEC 61000-4-6	50kHz-80MHz, 3Vrms ,Criteria A <sup>1)</sup>
Power Frequency Magnetic Fields	IEC 61000-4-8	3A/Meter, Criteria A <sup>1)</sup>
Voltage Dips	IEC 61000-4-11	100% dip; 0.5 cycle, Criteria A <sup>1)</sup> or Criteria B <sup>2)</sup> 30% dip; 10 cycle, Criteria A <sup>1)</sup> or Criteria B <sup>2)</sup>
Harmonic Current Emission	IEC 61000-3-2	Class C (230Vac @ ≥ 50% load)
Voltage Fluctuation & Flicker	IEC 61000-3-3	

1) Criteria A: Normal performance within the specification limits  
2) Criteria B: Temporary degradation or loss of function, which is self-recoverable

3) Asymmetrical: Common mode (Line to earth)  
4) Symmetrical: Differential mode (Line to line)

# LED Driver

## EUCI LITE Series

<b>Model Number</b>	EUCI-022105GLB	EUCI-040105GLB	EUCI-075105GLB	EUCI-130105GLB1	EUCI-170105GLB1
---------------------	----------------	----------------	----------------	-----------------	-----------------

### Default Settings of the Driver (can be changed with programmable tools)

Adjustable Output Current (AOC)	460mA	520mA	500mA	650mA	550mA
Smart Timer DIM	Disabled. Settable though programmable tools				
Module Temperature Protection (MTP)	Disabled. Settable though programmable tools				
Constant Lumen Output (CLO)	Disabled. Settable though programmable tools.				
End of Life indication (EOL)	Disabled. Settable though programmable tools				
Auxiliary Output	N/A				

### DALI Specification

Dimming range	5-100% duty
Standards	EN 62386-101 EN 62386-102 EN 62386-207

# LED Driver

## EUCI LITE Series

### Lifetime VS Case Temperature

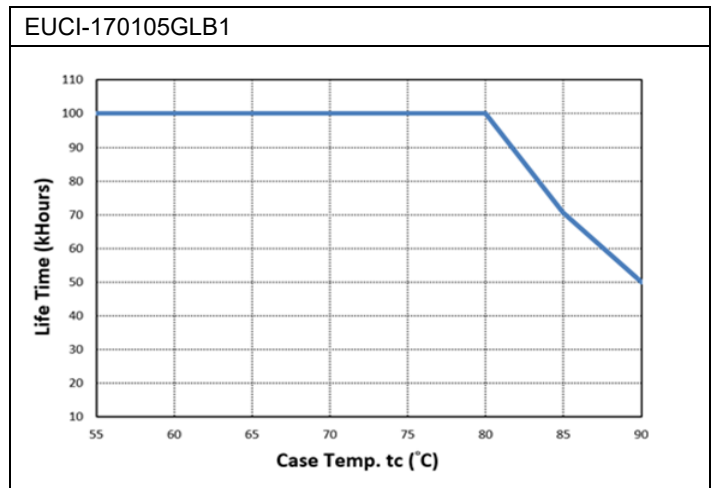
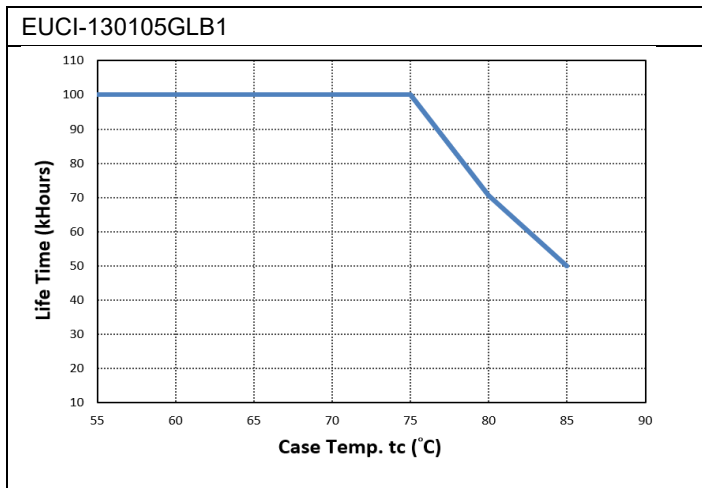
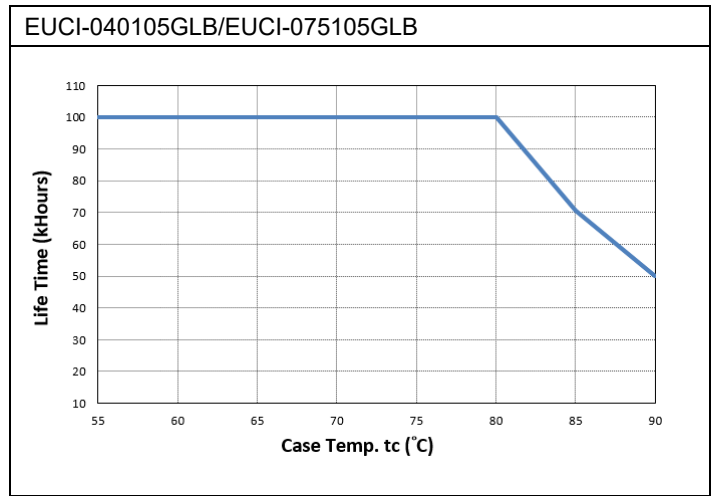
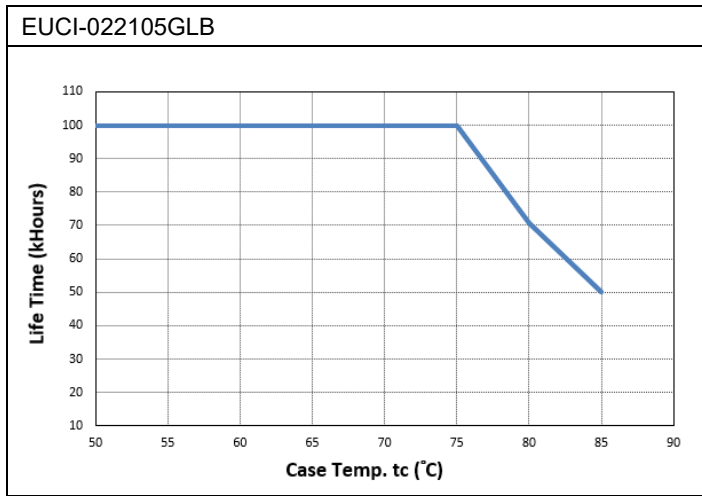

# LED Driver

## EUCI LITE Series

### Output and Dimming Characteristic Curve

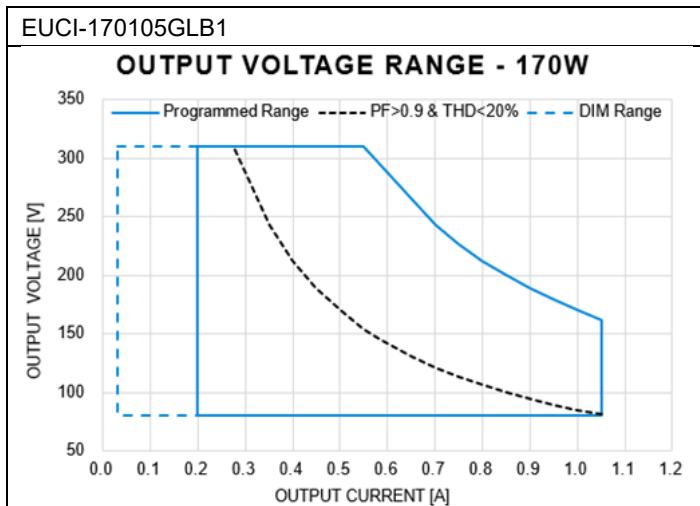
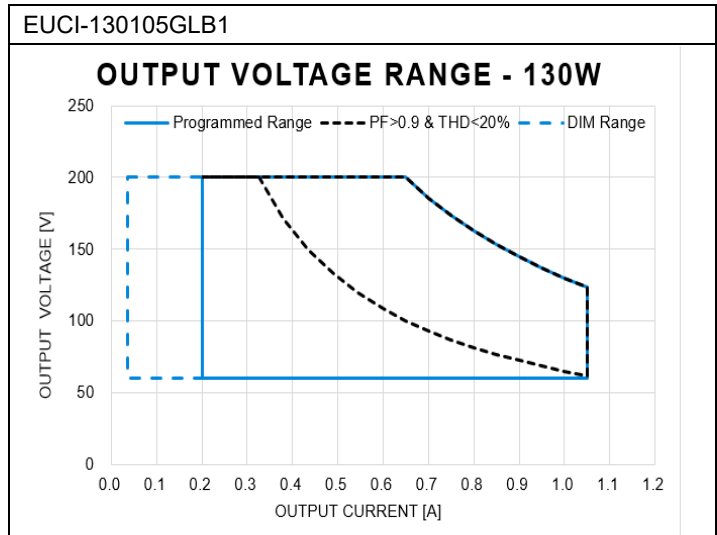
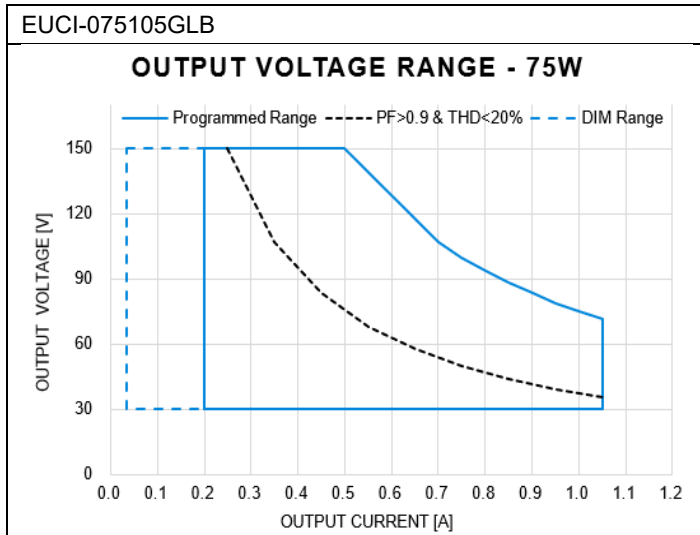
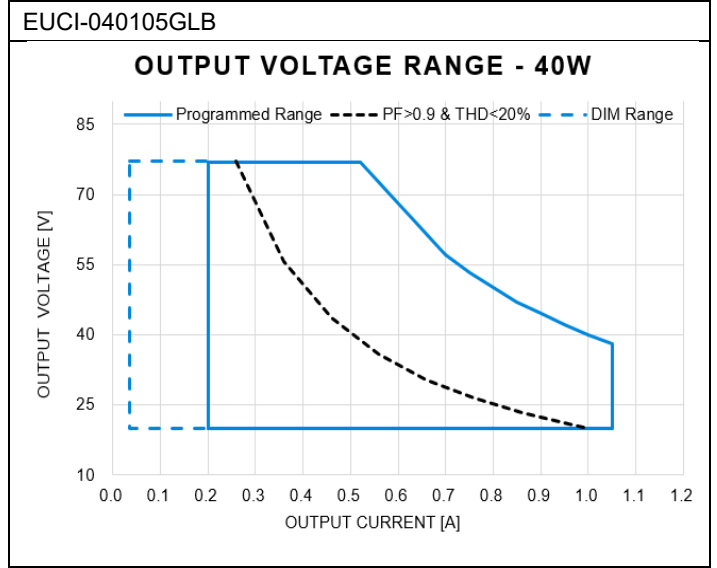
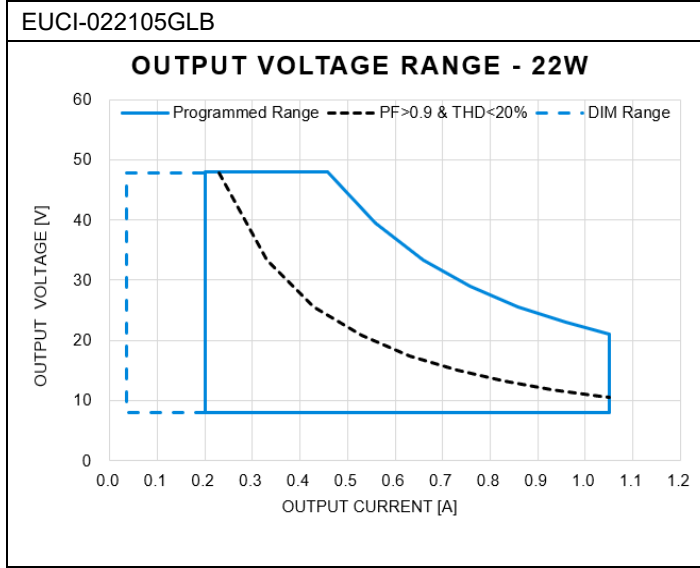

# LED Driver

## EUCI LITE Series

### Efficiency VS Output Power

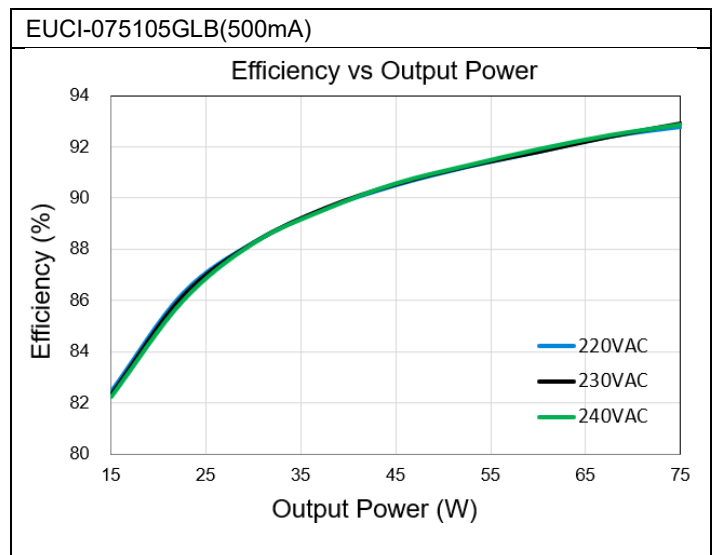
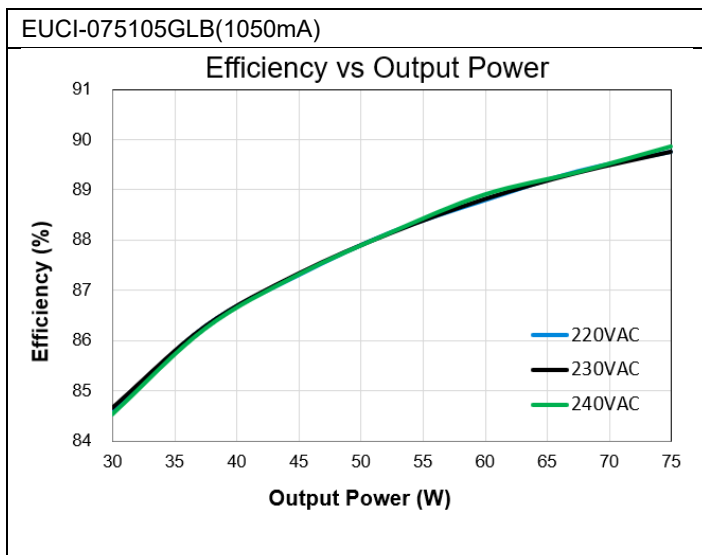
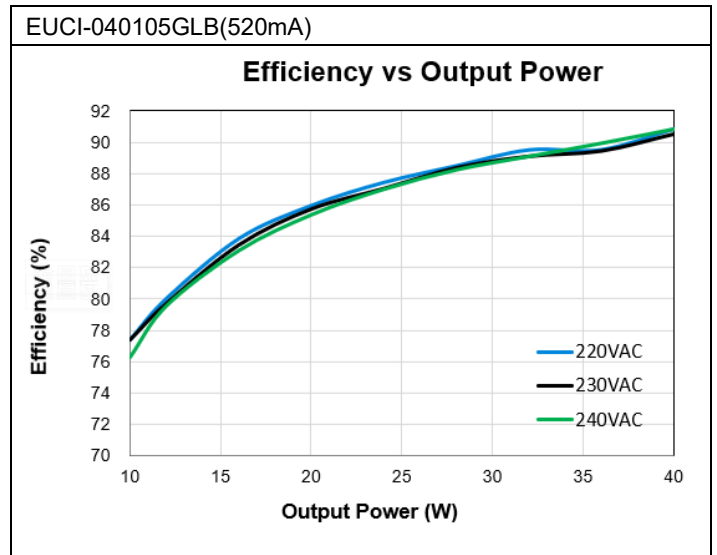
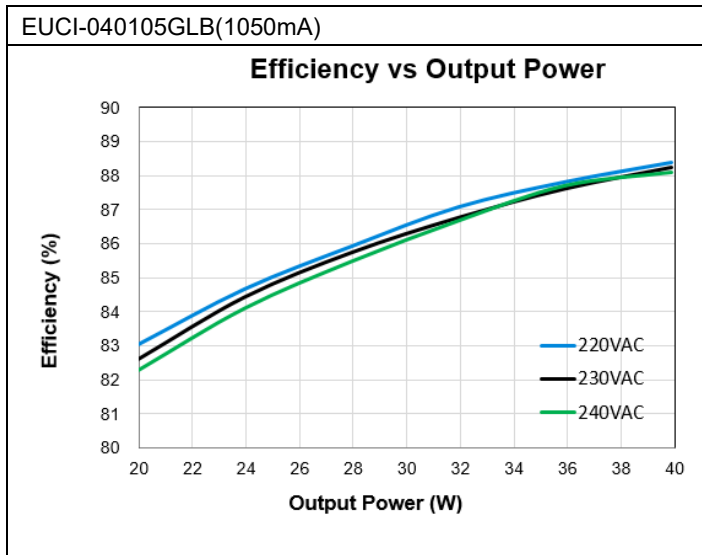
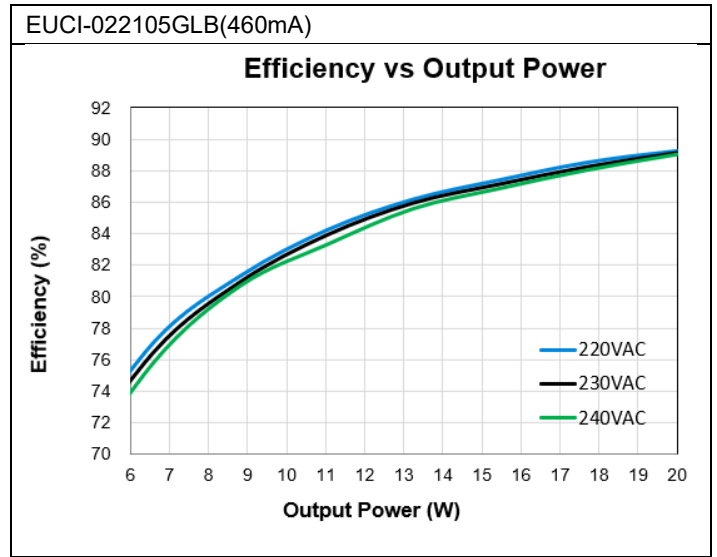
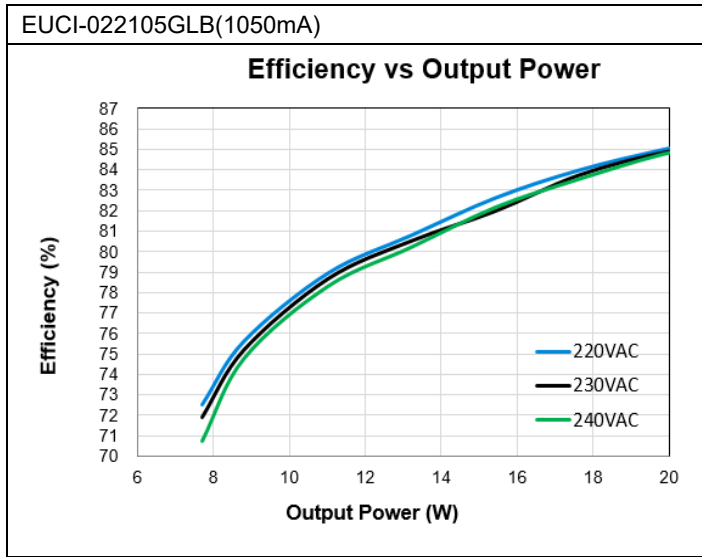



# LED Driver

## EUCI LITE Series

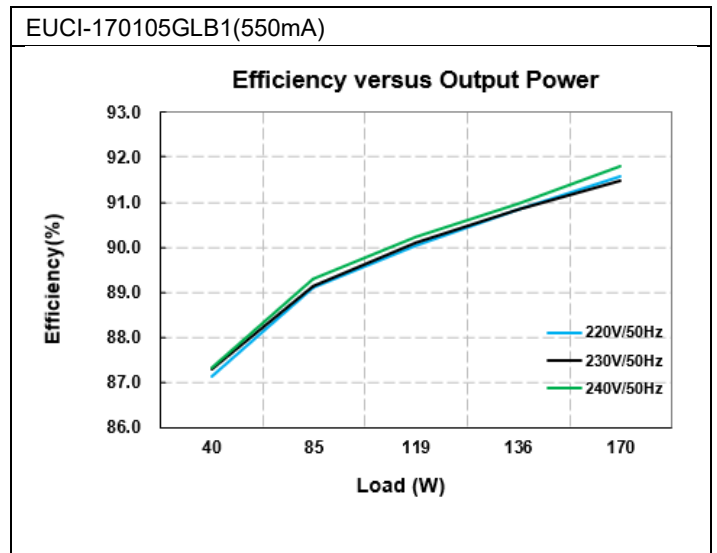
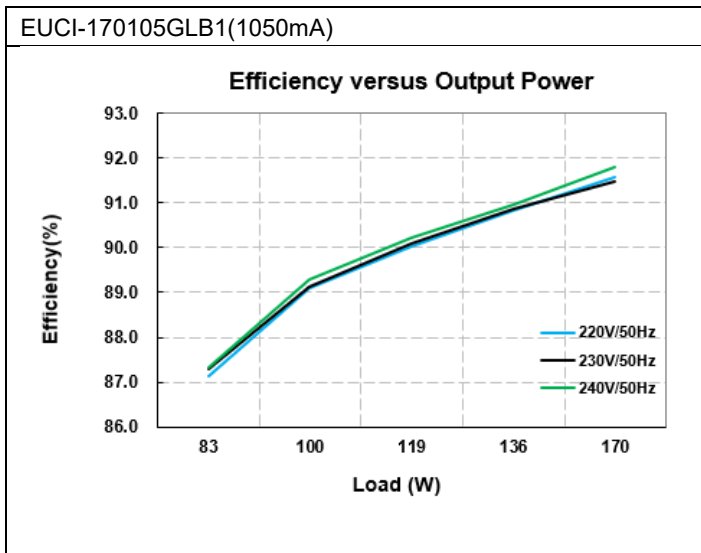
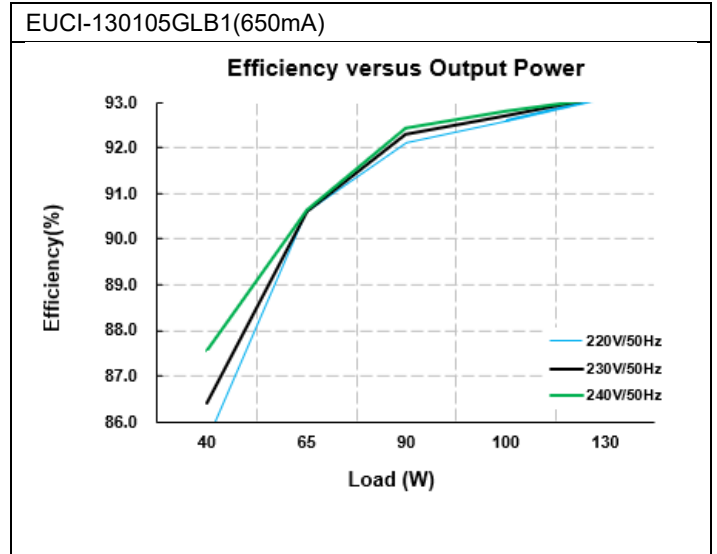
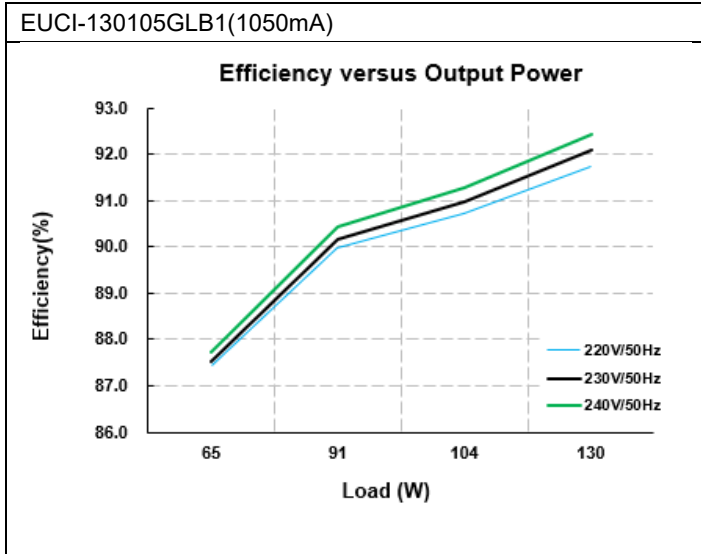

# LED Driver

## EUCI LITE Series

### Power Factor VS Output Power

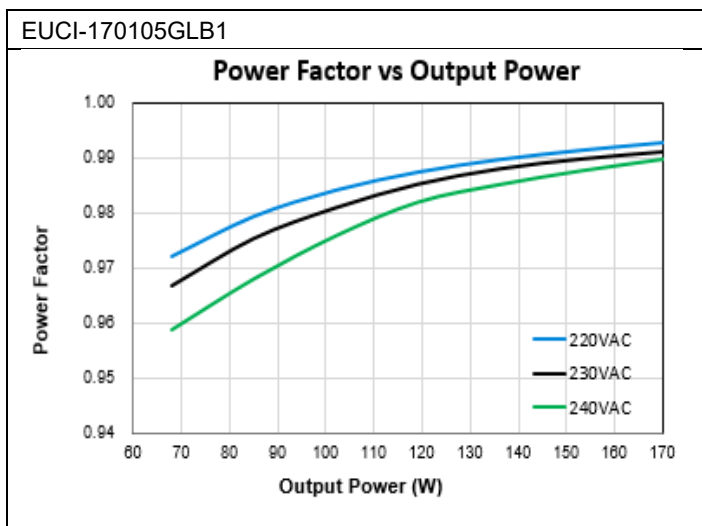
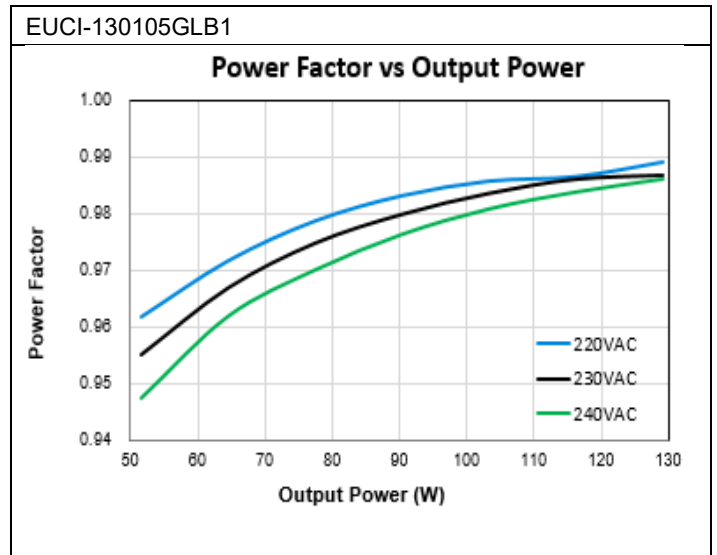
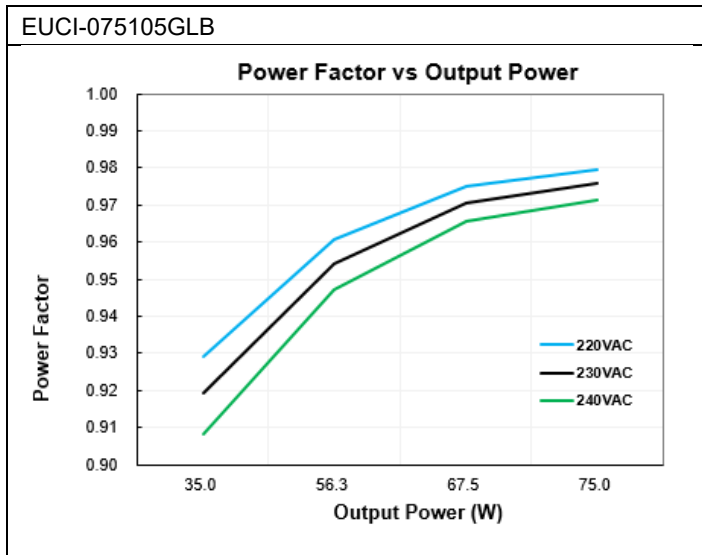
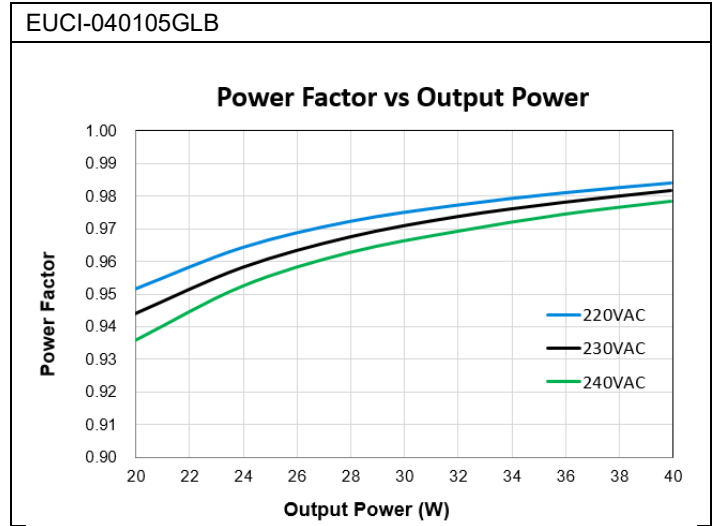
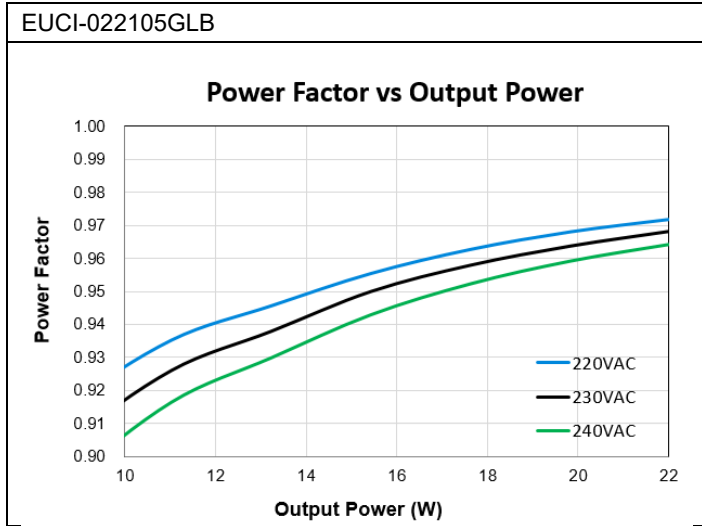

# LED Driver

## EUCI LITE Series

### Total Harmonic Distortion VS Output Power

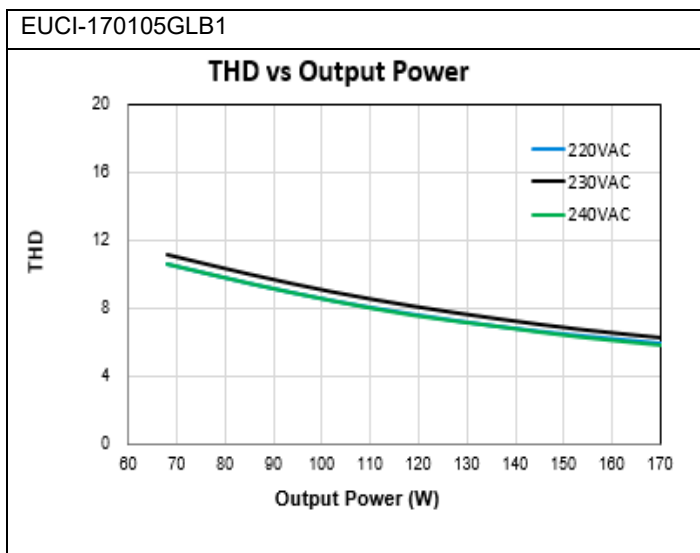
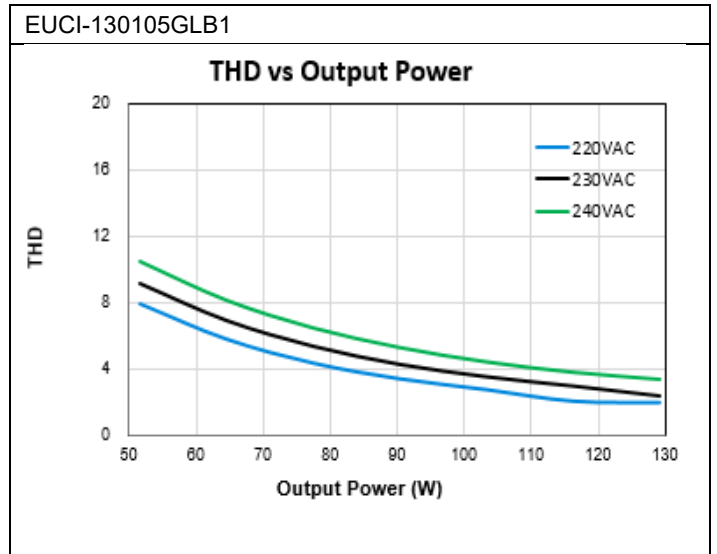
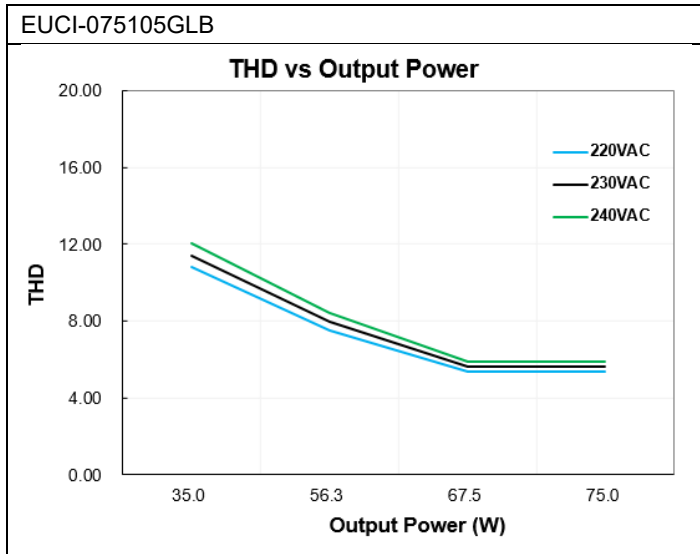
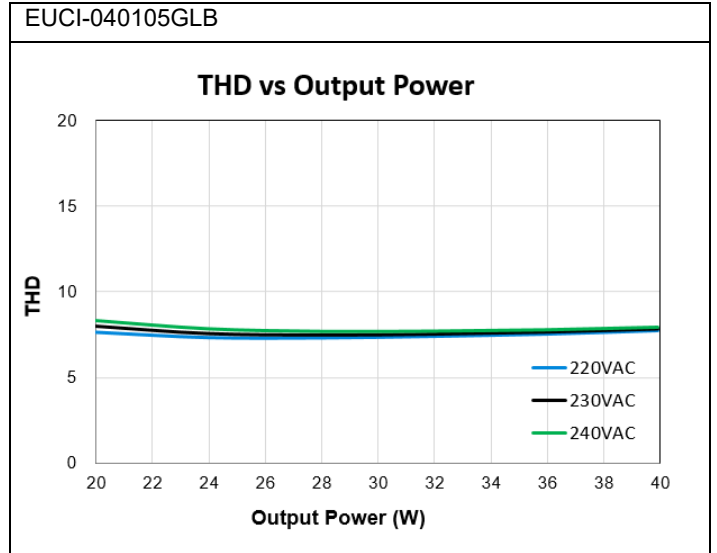
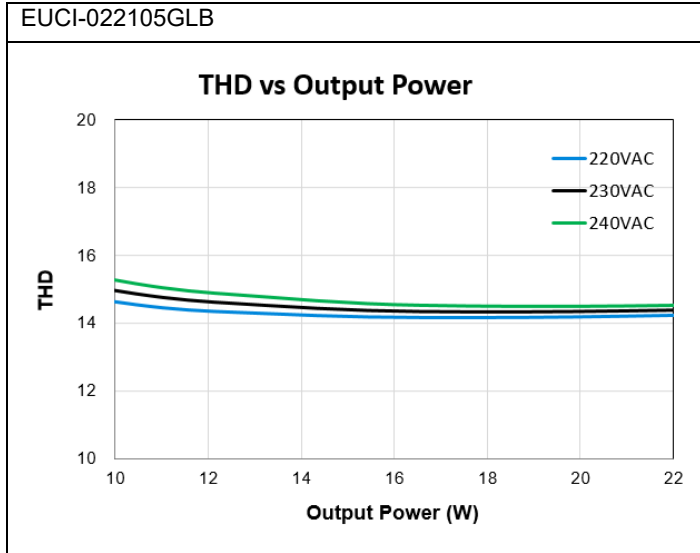

# LED Driver

## EUCI LITE Series

### Dimensions

EUCI-022105GLB & EUCI-040105GLB & EUCI-075105GLB

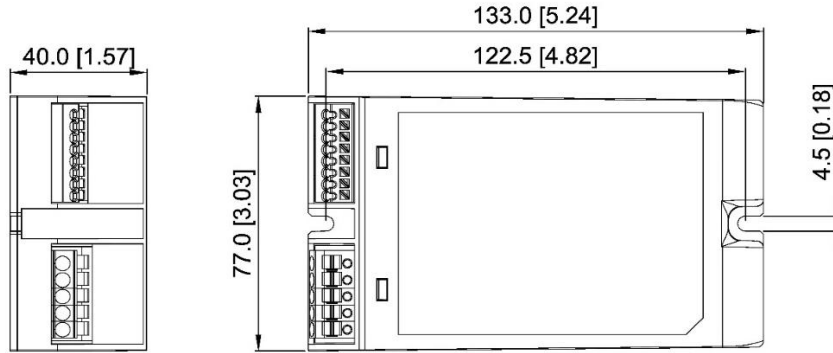

Unit: mm [inch]

EUCI-130105GLB1

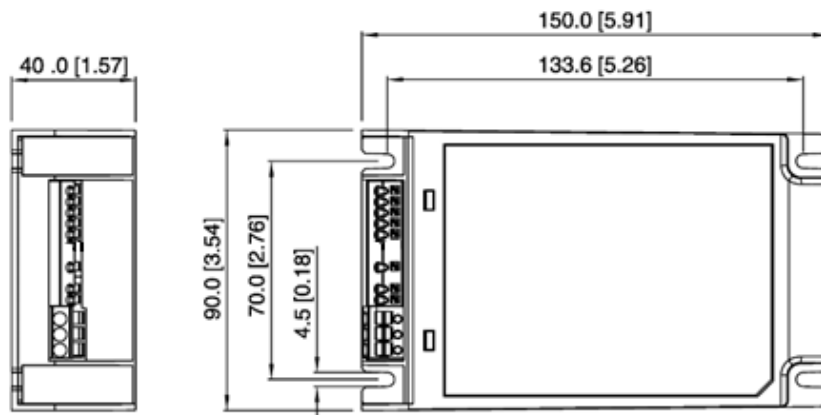

Unit: mm [inch]

EUCI-170105GLB1

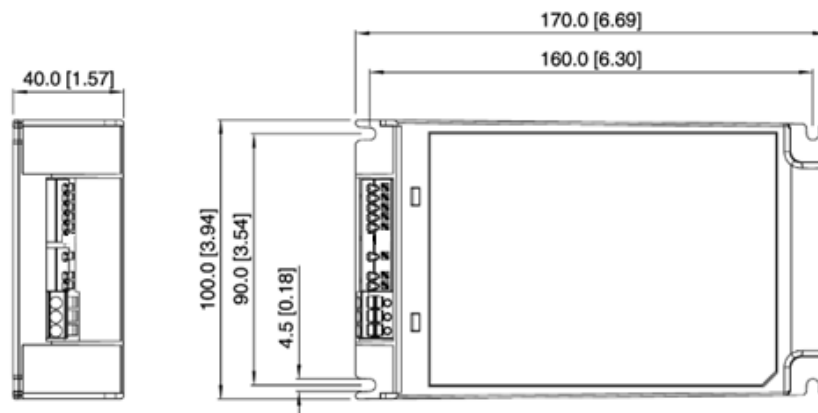

Unit: mm [inch]

# LED Driver

## EUCI LITE Series

### Functions

#### Touch DIM

Touch DIM offer an alternative group dimming control method without DALI Controller, one or multiple push button can be used as dimmer and connect to one or multiple EUCI Lite driver(s) as illustrated below

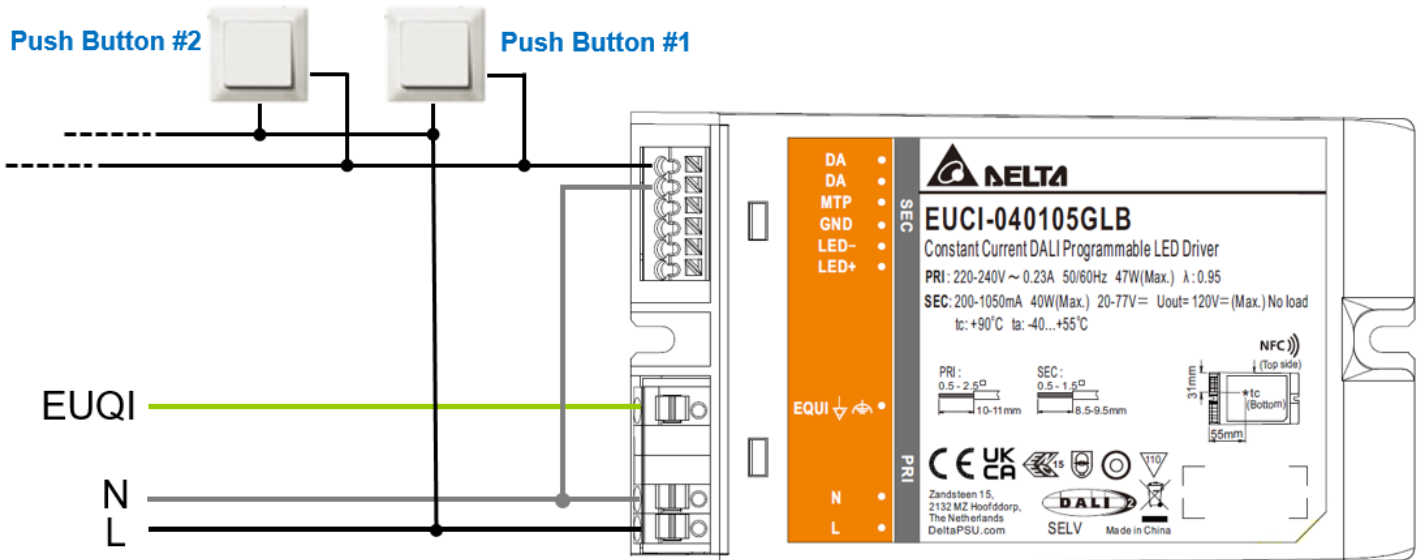

Touch DIM operations are summarized as the table below,

Touch DIM function	Contact duration	Dimming function
Ignore	< 60 ms	Ignore push
Short push	> = 60 ms and < 600 ms	Toggle the LED output ON/OFF
Long push	>= 600 ms	Dim the LED output up or down
Synchronize drivers	Long push -> short push -> long push	All drivers dimming level synchronize with each other

# LED Driver

## EUCI LITE Series

### Corridor Mode

Similar to Touch DIM, Corridor Mode is operated without DALI controller, the LED output is adjusted to a defined level when a presence sensor detects a movement object in the range then hold at define level for a certain time before go to a defined background level when presence sensor is released as the movement object is no longer in the detection range. The operation is illustrated as shown below

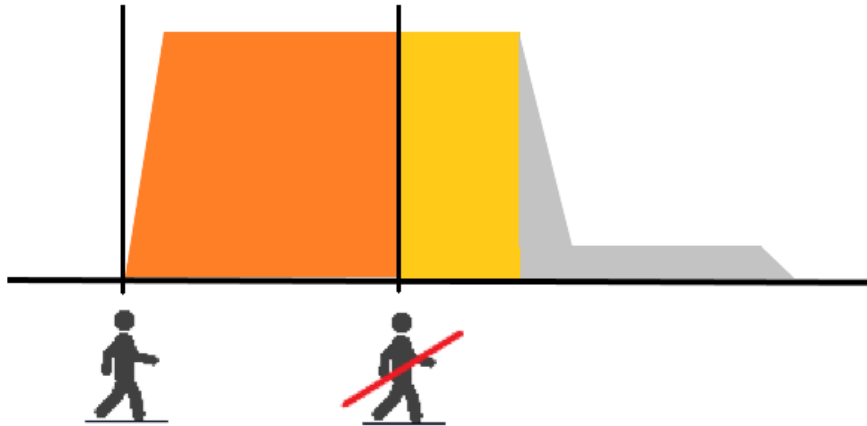

### Smart Timer Dim

Provides three operation modes: Fixed Timer, Midnight Centric Timer, Ratio Rescale Timer.

#### Fixed Timer

It is a memoryless-based dimming mode that tracks the output level based on the programmed timing curve. The output level is organized by scheduled profile in five steps.

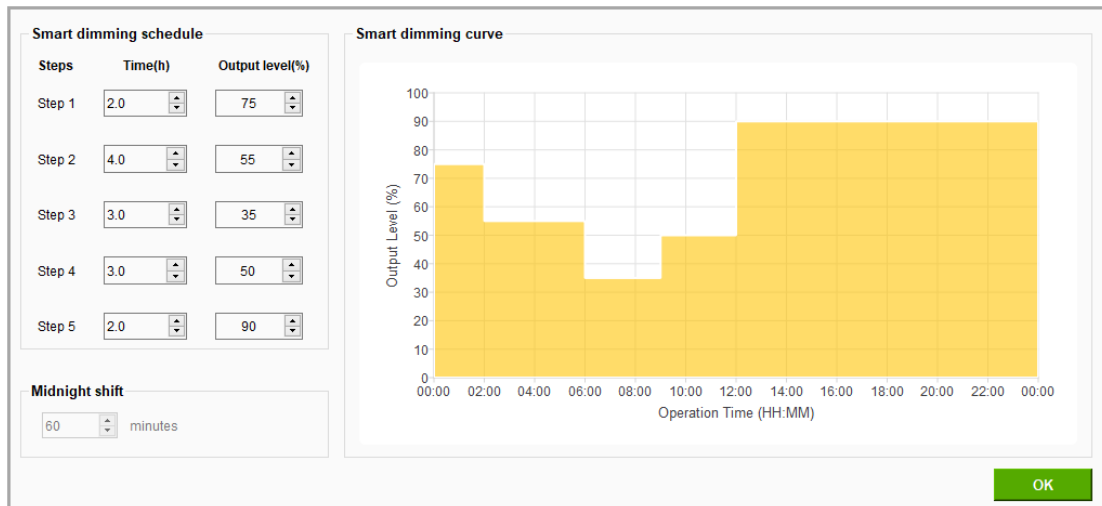

# LED Driver

## EUCI LITE Series

### Midnight Centric Timer

This mode is an memory-based that automatically measures over the past two days the power-on time of the lighting installation at which is the naturally corresponded to night time. The Midnight Centric Timer software calculates the length of power on time and centralized from the given virtual midnight point and change the output level accordingly. More specifically, when the LED driver is power-on during the very first two days or the power-on time difference of past two days is more than 15 minutes, the output current will fixed to the maximum level since there is no valid (reasonable) data for reference. Start from the third day and so on, when the power-on time difference of past two days is less than 15 minutes, the output level is controlled based on the correlation between the midnight point of programmed profile and yesterday power-on duration.



### Ratio Rescale Timer

This mode is similar to Midnight Centric Timer that records the power-on time based on the local night time. The Ratio Rescale Timer software rescale programmed output power profile of each step by a calculated percentage of the recorded power-on time (when valid) out of given 5 steps duration.

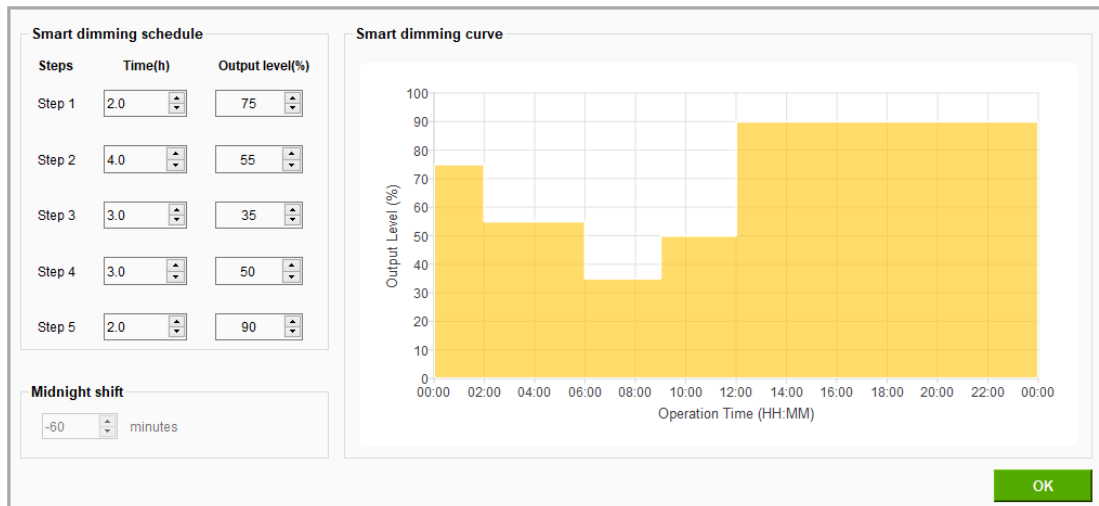

# LED Driver

## EUCI LITE Series

### Module Temperature Protection (for LED module)

In the LED luminaire system application, user can enable the MTP function by GUI and be taken to place the NTC thermistor close to the hottest spot on the LED module to avoid the abnormal high temperature on LED module. If LED thermal protection is not required the NTC wire of the LED driver can be left open. The de-rating limits can be programmed using the programming tool

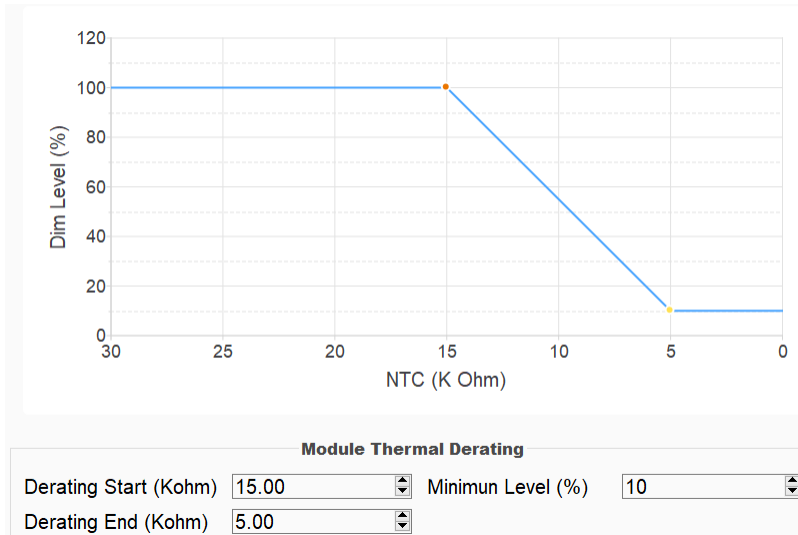

### Start-up Time

The time required for the output voltage to reach 90% of its final steady state set value, after the input voltage is applied.

### Rise Time

The time required for the output voltage to change from 10% to 90% of its final steady state set value.

### Hold-up Time

Time between the collapse of the AC input voltage, and the output falling to 95% of its steady state set value.

### ■ Graph illustrating the Start-up Time, Rise Time, and Hold-up Time

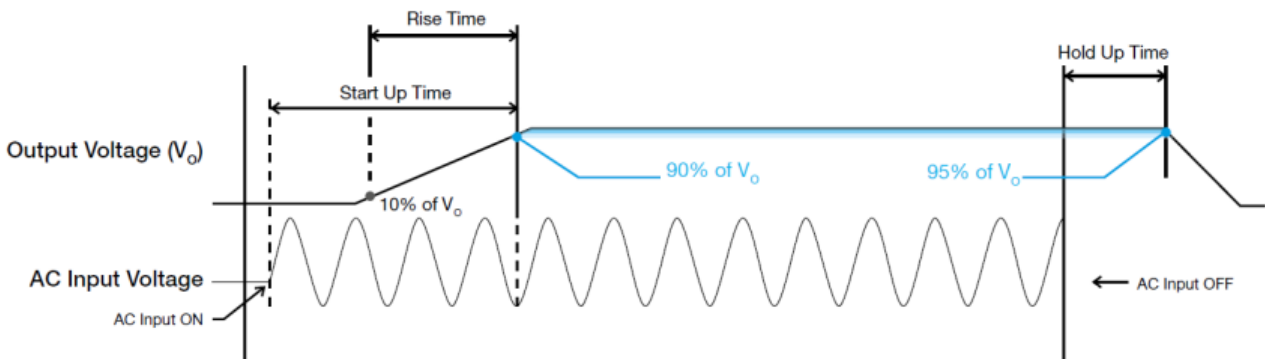



# LED Driver

## EUCI LITE Series

### Inrush Current

Inrush current is the peak, instantaneous, input current measured and, occurs when the input voltage is first applied. For AC input voltages, the maximum peak value of inrush current will occur during the first half cycle of the applied AC voltage. This peak value decreases exponentially during subsequent cycles of AC voltage.

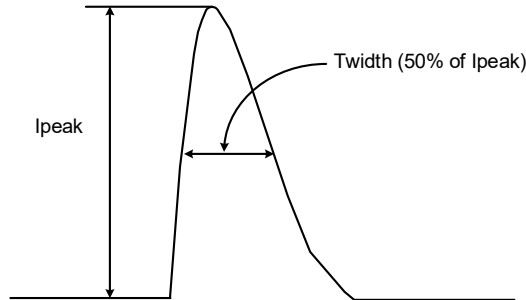

### Wired Connection and NFC program

EUCI-022105GLB / EUCI-040105GLB / EUCI- 075105GB

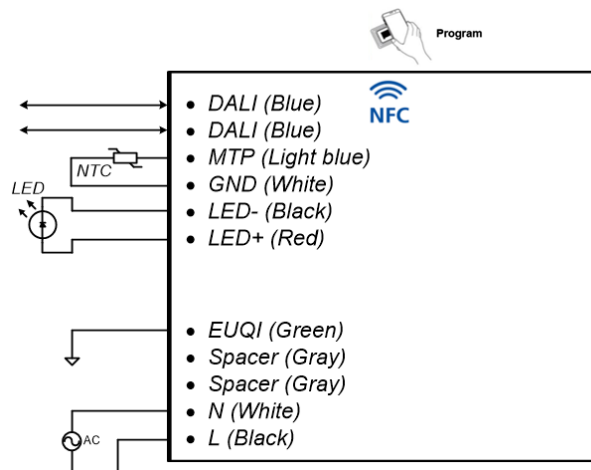

### Others and Protection

#### Delta RoHS Compliant



#### Restriction of the usage of hazardous substances

The European directive 2011/65/EU limits the maximum impurity level of homogeneous materials such as lead, mercury, cadmium, chrome, polybrominated flame retardants PBB and PBDE for the use in electrical and electronic equipment. RoHS is the abbreviation for “Restriction of the use of certain hazardous substances in electrical and electronic equipment”.

This product conforms to this standard.

#### PFC – Norm EN 61000-3-2

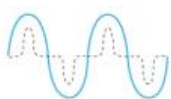

#### Line Current Harmonic content

Typically, the input current waveform is not sinusoidal due to the periodical peak charging of the input capacitor. In industrial environment, complying with EN 61000-3-2 is only necessary under special conditions. Complying with this standard can have some technical drawbacks, such as lower efficiency as well as some commercial aspects such as higher purchasing costs. Frequently, the user does not profit from fulfilling this standard, therefore, it is important to know whether it is mandatory to meet this standard for a specific application.

# LED Driver

## EUCI LITE Series

### Over Voltage Protections (Auto-Recovery)

The LED driver's Overvoltage Protections (OVP) will be activated when output voltage is achieved trigger point defined at OVP range. Upon such an occurrence, the  $I_o$  (output current) will start to droop.

### Short Circuit Protection (Auto-Recovery)

The LED driver's output OLP function also provides protection against short circuits. When a short circuit is applied, the LED driver will operate in "hiccup mode". It will return to normal operation after the short circuit is removed.

### Overload & Overcurrent Protection (Auto-Recovery)

The LED driver's Overload (OLP) and Overcurrent (OCP) Protections will be activated when output is between 95% and 108% of  $I_o$  (max load). Upon such an occurrence, the  $V_o$  (output voltage) will start to droop. Once the LED driver has reached its maximum power limit, the protection will be activated; and, the LED driver will operate in "CC mode". The LED driver will recover once the fault condition once the cause of OLP or OCP is removed, and  $I_o$  is back within the specified range.

### Over Temperature Protection (Auto-Recovery)

As mentioned above, the LED driver also has Over Temperature Protection (OTP). In the event of a higher operating temperature at 100% load, the LED driver will run into OTP when the operating temperature is beyond what is recommended in the de-rating graph. When activated, the output voltage will go into bouncing mode until the temperature drops to its normal operating temperature as recommended in the de-rating graph.

### Safety Instructions

- ALWAYS switch mains of input power OFF before connecting and disconnecting the input voltage to the device. If mains is not turned OFF, there is risk of explosion / severe damage.
- To guarantee sufficient convection cooling, keep a distance of 50mm above and lateral distance to other units.
- DO NOT insert any objects into the device.
- When the PE terminal is not connected, the device must be installed on a metal plate with PE connection.
- The current rating for the output cable must be rated higher than or equal to the output current of the power supply. Please refer to the product specifications.
- For device with dimming function, always ensure the dimming control is working properly. "Dimming 0-10V" shall be insulated from AC mains by reinforced insulation.

### Others

#### Warranty Policy

Please reach out our [Warranty Policy](#) should you require any further clarification.